



Conference call device

C520 WiMi

## **Administrator and Provisioning Manual**

# CONTENTS

<b>Preface</b> .....	<b>7</b>
Text Conventions.....	8
Audience .....	8
Related Documents.....	8
<b>Introducing the C520</b> .....	<b>9</b>
About the C520 conference phone .....	10
Quick Reference Guide.....	11
Network Requirements.....	13
C520 Configuration Methods .....	14
Adding a Custom Logo.....	15
Idle screen logo behavior.....	15
Logo specifications.....	15
Uploading a custom logo.....	16
Custom logo user interactions .....	16
Customizing Soft Keys .....	17
Custom soft key configuration file settings.....	17
<b>Configuration Using the Phone Menus</b> .....	<b>20</b>
Viewing the Main Menu.....	21
Using the Status menu .....	21
Viewing Line status .....	23
Using the Admin Settings Menu.....	24
Using the Network Setting menu .....	25
Using the Line menu .....	28
Using the Provisioning menu .....	29
<b>Using the WebUI</b> .....	<b>30</b>
Using the Web User Interface (WebUI) .....	31
Status Page.....	33
System Status .....	33
System Pages .....	34
SIP Account Management .....	34
General Account Settings.....	34

Dial Plan .....	36
SIP Server Settings .....	37
Registration Settings .....	37
Outbound Proxy Settings.....	37
Backup Outbound Proxy Settings .....	38
Audio Settings .....	38
Quality of Service .....	39
Signaling Settings.....	39
Feature Access Codes Settings .....	40
Voicemail Settings .....	42
NAT Traversal.....	43
Music on Hold Settings.....	43
Network Conference Settings.....	43
Session Timer.....	44
Call Settings .....	45
General Call Settings.....	45
Do Not Disturb .....	45
Call Forward .....	46
Preferences.....	47
General User Settings .....	47
Call Hold Reminder .....	48
Call Waiting .....	48
Program Dial Keys .....	49
Speed Dial.....	50
Speed Dial Keys .....	51
Signaling Settings .....	52
Voice .....	52
NAT Traversal.....	52
Ringer Settings.....	53
Paging Zones .....	54
Network Pages.....	55
Basic Network Settings .....	55
Basic Network Settings.....	55
Advanced Network Settings.....	56
VLAN .....	56
LLDP-MED .....	57
802.1x.....	57
Contacts Pages.....	58
Local Directory .....	58
Create Local Directory Entry .....	60
Directory Import/Export.....	60
Blacklist .....	61
Create Blacklist Entry .....	62
Blacklist Import/Export.....	63
LDAP.....	64
LDAP Settings .....	64
Broadsoft.....	67
Broadsoft Phonebook Settings.....	67
Call History.....	68

Servicing Pages .....	69
Reboot.....	69
Time and Date .....	69
Time and Date Format.....	70
Network Time Settings .....	70
Time Zone and Daylight Savings Settings.....	70
Manual Time Settings.....	71
Firmware Upgrade .....	72
Firmware Server Settings.....	72
Manual Firmware Update and Upload.....	73
Provisioning.....	74
Provisioning Server .....	75
Plug-and-Play Settings .....	75
DHCP Settings .....	76
Resynchronization .....	76
Import Configuration .....	78
Export Configuration .....	78
Reset Configuration.....	79
Security .....	80
Passwords .....	80
Web Server.....	81
Certificates .....	81
Device Certificate .....	82
Server Certificate.....	82
System Logs .....	83
Syslog Settings.....	83
Network Trace .....	84
Download Log.....	84
<b>Provisioning Using Configuration Files.....</b>	<b>85</b>
The Provisioning Process .....	86
Resynchronization: configuration file checking.....	87
C520 restart .....	87
Configuration File Types .....	88
Data Files .....	89
Configuration File Tips and Security .....	90
Clearing parameters with %NULL in configuration file .....	90
Guidelines for the MAC-Specific configuration file.....	90
Securing configuration files with AES encryption .....	91
<b>Configuration File Parameter Guide.....</b>	<b>93</b>
"sip_account" Module: SIP Account Settings.....	95
General configuration file settings.....	95
MAC-specific configuration file settings .....	105
"network" Module: Network Settings.....	107
General configuration file settings.....	107
MAC-specific configuration file settings .....	109

---

"provisioning" Module: Provisioning Settings .....	111
"time_date" Module: Time and Date Settings .....	116
"log" Module: Log Settings .....	120
"remoteDir" Module: Remote Directory Settings .....	121
"web" Module: Web Settings.....	126
"user_pref" Module: User Preference Settings .....	127
General configuration file settings.....	127
MAC-specific configuration file settings .....	128
"call_settings" Module: Call Settings.....	131
"speed_dial" Module: Speed Dial Settings.....	133
"ringersetting" Module: Distinctive Ringer Settings.....	134
"file" Module: Imported File Settings .....	135
General configuration file settings.....	135
MAC-specific configuration file settings .....	136
"tone" Module: Tone Definition Settings .....	138
"profile" Module: Password Settings .....	141
General configuration file settings.....	141
MAC-specific configuration file settings .....	141
"page_zone" Module: Paging Zone Settings .....	142
"softkey" Module: Custom Soft Key Settings .....	144
"bt_settings" Module: Bluetooth Settings .....	146
<b>Troubleshooting .....</b>	<b>147</b>
Common Troubleshooting Procedures .....	147
<b>Appendix.. .....</b>	<b>150</b>
Appendix A: Maintenance .....	150



# PREFACE

Please thoroughly read this manual for all the feature operations and troubleshooting information necessary to install and operate your new device.

This administrator and provisioning manual contains detailed instructions for installing and configuring The C520 WiMi Conference Phone with software version 1.1.6.x or newer. See *“Using the Status menu” on page 21* for instructions on checking the software version on the device. Please read this manual before installing the product.

Please print this page and record the following information regarding your product:

Model number: C520 WiMi

Type: Small-to-medium business SIP-endpoint conference phone

Serial number: \_\_\_\_\_

Purchase date: \_\_\_\_\_

Place of purchase: \_\_\_\_\_



Both the model and serial numbers can be found on the bottom of the device.

Save your sales receipt and original packaging in case it is necessary to return your telephone for warranty service.

## Text Conventions

Table 1 lists text formats and describes how they are used in this guide.

**Table 1. Description of Text Conventions**

Text Format	Description
<b>Screen</b>	Identifies text that appears on a device screen or a WebUI page in a title, menu, or prompt.
<b>HARD KEY</b> or <b>DIAL-PAD KEY</b>	Identifies a hard key, including the dial-pad keys.
<b>CallFwd</b>	Identifies a soft key.
 Notes provide important information about a feature or procedure.	Example of a Note.
 <i>A caution means that loss of data or unintended circumstances may result.</i>	Example of a Caution.

## Audience

This guide is written for installers and system administrators. It assumes that you are familiar with networks and VoIP, both in theory and in practice. This guide also assumes that you have ordered your IP PBX equipment or service and selected which PBX features you want to implement. This guide references specific IP PBX equipment or services only for features or settings that have been designed for a specific service. Please consult your equipment supplier or service provider for recommended switches, routers, and firewall and NAT traversal settings, and so on.

As the C520 Conference becomes certified for IP PBX equipment or services, Snom may publish interop guides for those specific services. The interop guides will recommend second-party devices and settings, along with C520-specific configurations for optimal performance with those services. For the latest updates, visit our Wiki at <http://wiki.snom.com/Category:C520>.

The download links for the Quick Installation Guides and the User Manual for the C520 WiMi, the C52 Speakerphone, and the C520 Replacement Microphone are also located at the above link.



## CHAPTER 1

# INTRODUCING THE C520

This administrator and provisioning guide contains detailed instructions for configuring the C520 WiMi Conference Phone. Please read this guide before attempting to configure the C520.

Some of the configuration tasks described in this chapter are duplicated in the Web User Interface (WebUI) described in the next chapter, but if you need to assign static IP addresses, they must be set at each device.

This chapter covers:

- *“About the C520 conference phone” on page 10*
- *“Quick Reference Guide” on page 11*
- *“Network Requirements” on page 13*
- *“C520 Configuration Methods” on page 14*
- *“Adding a Custom Logo” on page 15*
- *“Customizing Soft Keys” on page 17.*

## About the C520 conference phone

The C520 WiMi Conference Phone is a conference phone designed to work with popular SIP telephone (IP PBX) equipment and services. Once you have ordered and configured your SIP equipment or service, the C520 enables you to make and receive calls as you would with any other business phone. In addition to its speakerphone and conferencing features, the C520 provides calling features like hold, transfer and speed-dial numbers.

The C520 conference phone features include:

- 2.5-inch backlit Liquid Crystal Display
- Bluetooth and DECT connectivity for cell phones and headsets
- Up to 3 SIP account registrations
- Up to 6 active SIP sessions
- 3-way conferencing
- 200-entry Call Log

You can configure the C520 using the menus on the phone, a browser-based interface called the WebUI, or an automatic provisioning process (see *“Provisioning Using Configuration Files”* on page 85). The WebUI enables you to configure the C520 using a computer that is connected to the same Local Area Network. The WebUI resides on the device and may get updated with firmware updates.

## Quick Reference Guide

The external features of the C520 conference phone are described below.

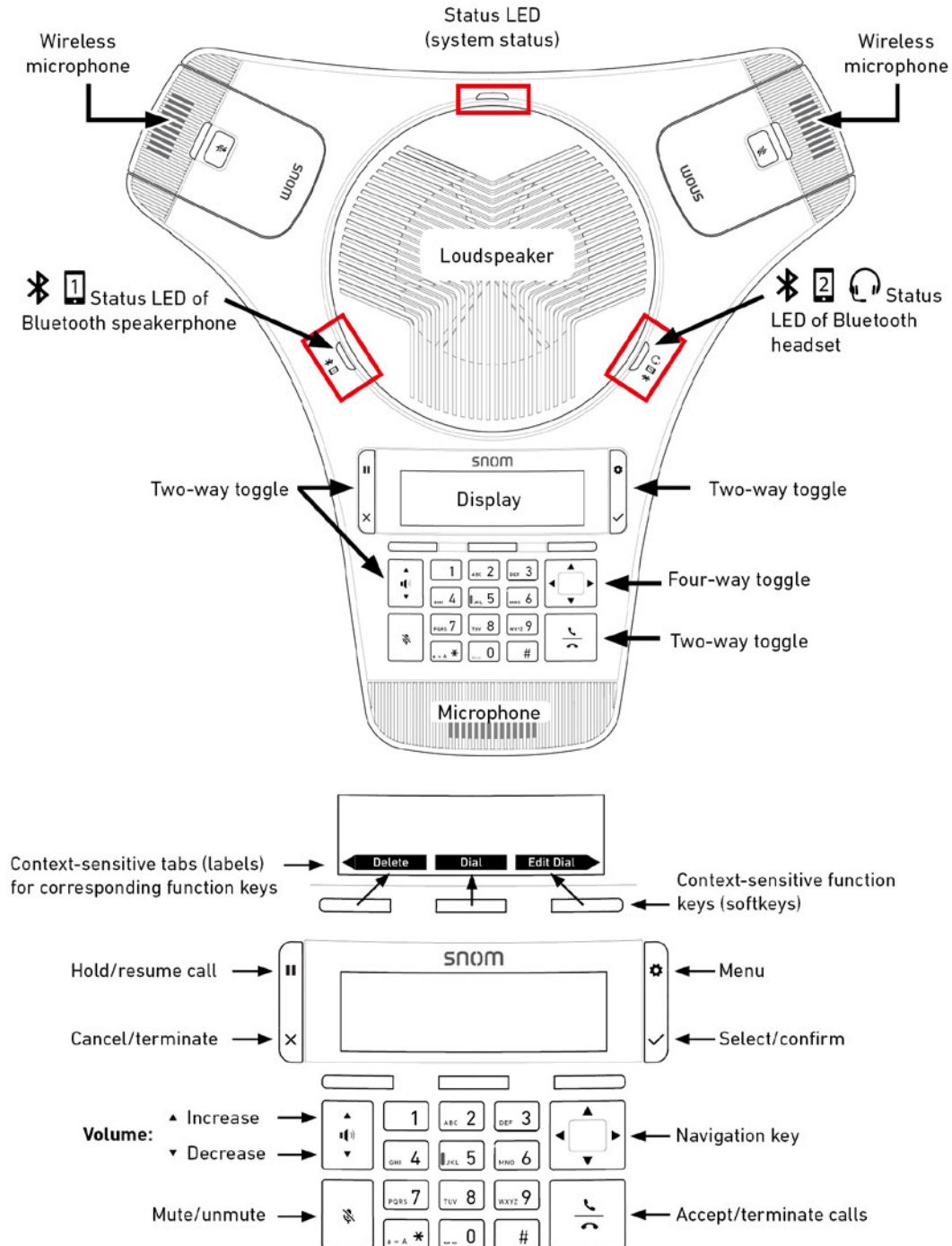

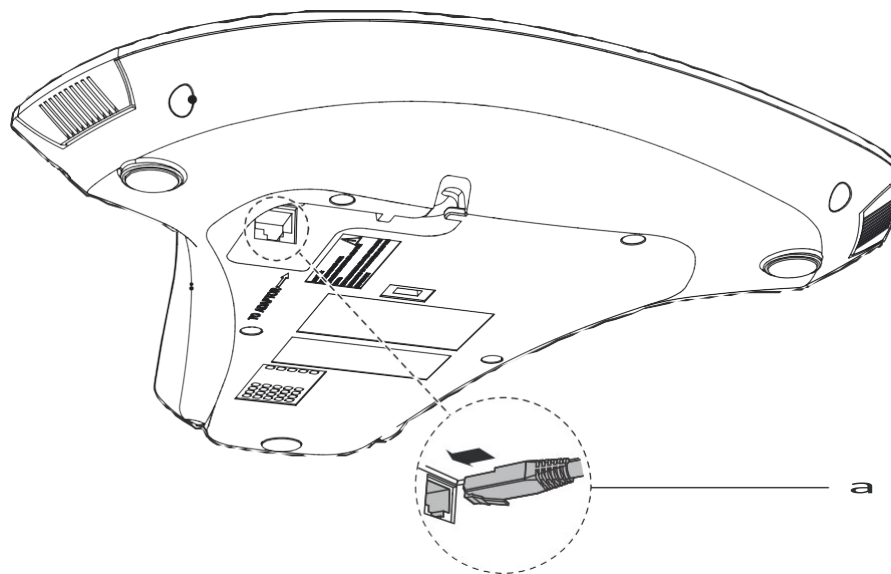

R45 jack (power and network)

- With PoE: To network
- Without PoE: To power and network via adapter

## Network Requirements

A simple C520 WiMi Conference Phone installation example is shown in Figure 1. A switched network topology is recommended for your LAN (using standard 10/100 Ethernet switches that carry traffic at a nominal rate of 100 Mbit/s).

The office LAN infrastructure should use Cat.-5/Cat.-5e cable.

The C520 requires a wired connection to the LAN. However, wireless connections from your LAN to other devices (such as laptops) in your office will not impede performance.

A Dynamic Host Configuration Protocol (DHCP) server is recommended and must be on the same subnet as the C520 conference phones so that IP addresses can be auto-assigned. In most cases, your network router will have a DHCP server. By default, the C520 has DHCP enabled for automatic IP address assignment.



Some DHCP servers have default settings that limit the number of network IP addresses assigned to devices on the network. You should log in to your server to confirm that the IP range is sufficient.

If no DHCP server is present, you can assign a static IP to the C520. You can assign a static IP address using the C520 menu. To assign a static IP, go to **Admin settings > Network setting > Set static IP**. If you do not have a DHCP server or do not manually assign static IPs, you will not be able to access the WebUI and/or enable automatic time updates from an NTP server.

A DNS server is recommended to resolve the path to the Internet and to a server for firmware and configuration updates. If necessary, the system administrator can also download upgrade files and use the WebUI to update the C520 firmware and/or configuration settings manually.

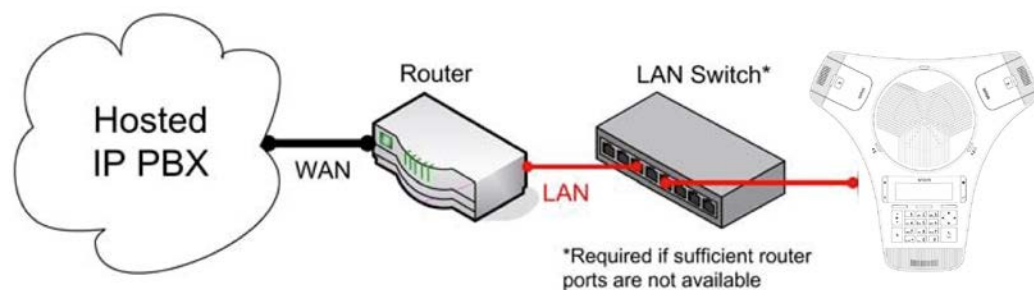

Figure 1. C520 Installation Example

## C520 Configuration Methods

You can configure the C520 using one of the following methods:

- From the C520 itself, using the menus. The C520 menus are best suited to configuring a few settings, perhaps after the initial setup has been done. For administrators, the settings available on the C520 menus include network settings, account settings, and provisioning settings. See *“Using the Admin Settings Menu” on page 24*. Many of the settings accessible on the C520 are most useful for end users. Through the menu, they can customize the screen appearance, sounds, and manage calls. For more information, see the C520 User Guide.
- The Web User Interface, or WebUI, which you access using your Internet browser. See *“Using the WebUI” on page 30*. The browser-based interface is easy to navigate and best suited to configuring a large number of C520 settings at once. The WebUI gives you access to every setting required for configuring a single device. You can enter service provider account settings on the WebUI, and set up provisioning, which will allow you to automatically and remotely update the C520 after initial configuration.
- Provisioning using configuration files. Working with configuration files allows you to configure the device at regular intervals. There are several methods available to enable the C520 to locate and upload the configuration file. For example, you can enable the C520 to check for the presence of a configuration file on a provisioning server when it starts up or reboots. If the configuration file is new or has been modified in any way, the C520 automatically downloads the file and applies the new settings. For more information, see *“Provisioning Using Configuration Files” on page 85*.

## Adding a Custom Logo

You can upload a custom logo to be displayed on the phone idle screen and during bootup. Uploading a logo is done using the configuration file. The parameters for uploading a custom logo are described in *“Uploading a custom logo” on page 16*. The default logo for bootup and idle mode is the **Snom** logo.

The behavior described below is disabled by default.

You can enable the logo to appear instead of the idle screen after a specified period of inactivity. The parameter for setting the delay before the logo appears is in the General configuration file. See *“user\_pref.idle\_to\_logo\_timeout” on page 127*.

You can enable the phone screen to cycle between the logo and the idle screen when the phone is in idle mode by setting both the `user_pref.idle_to_logo_timeout` and the `user_pref.logo_to_idle_timeout` parameters. See *“user\_pref.logo\_to\_idle\_timeout” on page 127*.

### Logo specifications

The file type and dimensions for the logo are listed below.

**File type:** Monochrome bitmap (.bmp)

**Dimensions (w × h):** Idle screen and bootup logo: 158 × 57 pixels

Positioning a custom logo on the screen is a matter of creating a logo with the maximum dimensions listed above, including any surrounding white space. Note that the width of the logo specified in the table above is the same as the width of the C520 screen (158 pixels). There are no configuration file settings to specify the x-axis or y-axis position of the logo on the screen.

## Uploading a custom logo

The `file.bootup_logo` and `file.idle_logo` parameters in the configuration file allow you to upload a custom bootup logo and custom idle logo. Place the logos on your server and enter the URL for each logo for the `file.idle_logo` and `file.bootup_logo` parameters.

If the downloaded logo is found to be invalid, the syslog will record one of the following errors:

- file not found
- invalid file format
- incorrect image size
- image is not in black and white

## Custom logo user interactions

For C520 users, pressing any hard key will exit the idle logo and perform the key's function. For example, pressing **MENU** will show the Main Menu.

Pressing a soft key when the idle logo is showing will switch to the idle screen.



## Customizing Soft Keys

The configuration file allows you to select which soft keys can appear on the Idle screen, the Active Call screen, the Held Call screen and the Live Dial screen. You can also specify the position of each soft key.

Some soft keys appear only under certain conditions. For example, the Line soft key on the Idle screen appears only if there is more than one registered SIP account. When a "conditional" soft key is not visible, the soft key's position is left empty.

Soft key levels with no soft keys will not be shown if there are multiple soft key levels (as indicated by the ◀ and ▶ icons). Any soft key level where all soft keys are invisible will be dynamically skipped when the user navigates through the available levels. On the C520, a soft key level consists of three soft keys (populated or blank) in a row.

Table 2 shows the soft key options available for each screen. Each screen can have a maximum of nine soft keys.

For the custom soft key configuration file parameters, see *""softkey" Module: Custom Soft Key Settings" on page 144.*

### Custom soft key configuration file settings



NOTE

You cannot edit soft key text. The configuration file parameters allow you to only select and position the soft keys for each screen.

**Table 2. Custom Soft Keys**

Screen	Available Soft Keys	Soft Key Text
Idle	Blank	
	Directory	Directory
	Call Log	Call Log
	Redial	Redial
	Messages	Message
	Do Not Disturb	DND
	Call Forward	CallFwd
	Call Forward All	FwdAll
	Call Forward No Answer	CFNA
	Call Forward Busy	FwdBusy
	Intercom	Intercom
	Retrieve Parked Call	Retrieve
	Call Return	CallBack
Group Call Pickup	GrpPickup	

**Table 2. Custom Soft Keys**

Screen	Available Soft Keys	Soft Key Text
	Direct Call Pickup	<b>DirPickup</b>
	Line (visible with more than one account assigned)	<b>Line</b>
	Settings	<b>Settings</b>
	Bluetooth connect	<b>Connect</b>
	Bluetooth device 1	<b>Device 1</b>
	Bluetooth device 2	<b>Device 2</b>
	Program Dial (up to three Program Dial keys)	<b>[Custom]</b>
Call Active	Blank	
	New	<b>New</b>
	Park Call	<b>Park</b>
	End	<b>End</b>
	Hold	<b>Hold</b>
	Transfer	<b>Transfer</b>
	Conference	<b>Conf</b>
	XferLine (visible with more than one call)	<b>XferCall</b>
	ConfLine (visible with more than one call)	<b>ConfCall</b>
	Private hold	<b>Priv hold</b>
	Bluetooth connect	<b>Connect</b>
	Bluetooth device 1	<b>Device 1</b>
	Bluetooth device 2	<b>Device 2</b>
	Program Dial (up to three Program Dial keys)	<b>[Custom]</b>
Call Held	Blank	
	End	<b>End</b>
	New	<b>New</b>
	Park Call	<b>Park</b>
	Retrieve Parked Call	<b>Retrieve</b>
	Group Call Pickup	<b>GrpPickup</b>
	Direct Call Pickup	<b>DirPickup</b>
	Resume	<b>Resume</b>

**Table 2. Custom Soft Keys**

Screen	Available Soft Keys	Soft Key Text
	Transfer	Transfer
	Conference	Conf
	XferLine (visible with more than one call)	XferCall
	ConfLine (visible with more than one call)	ConfCall
	Program Dial (up to three Program Dial keys)	[Custom]
Live Dial	Blank	
	Directory	Directory
	Call Log	Call Log
	Redial	Redial
	Messages	Message
	End	End
	Dial	Dial
	Input (letter/number selection)	123
	Cancel	Cancel
	Backspc	Backspc
	Bluetooth connect	Connect
	Bluetooth device 1	Device 1
	Bluetooth device 2	Device 2
	Program Dial (up to three Program Dial keys)	[Custom]

The custom soft keys parameters are included in the "softkey" module. For more information, see *“softkey” Module: Custom Soft Key Settings* on page 144. To modify a soft key parameter, enter values separated by commas. Soft keys appear on the phone screen in the same order as the soft key values you enter. For example, the parameter/value combination of `softkey.idle = line,dir,settings` will result in the Idle screen shown below:

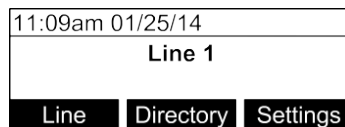

# CONFIGURATION USING THE PHONE MENUS

The C520 Main Menu has the following sub-menus:

- **Features**—manage calls and Bluetooth devices, view and add directory entries, view call history, access messages, and use the speed dial menu.
- **Status**—view the C520 network status, account registration status, and product information.
- **User Settings**—allows the user to set the language for the display, configure the appearance of the display, edit programmable keys, register wireless microphones and DECT speakers, and customize the audio settings.
- **Admin settings**—configure network settings (enter static IP addresses, for example), account settings and provisioning settings.

This chapter contains instructions for using the Admin Settings menu and for accessing the Status menu. See the C520 User Guide for more information about the Features menu and User Settings menu.

## Viewing the Main Menu

### *To use the C520 menu:*

1. When the C520 is idle, press **MENU**.  
The **Main Menu** appears.

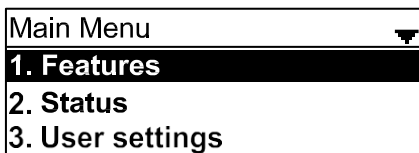

2. Press **▼** or **▲** to highlight the desired sub-menu, and then press **SELECT**.
  - You can also press a corresponding dial pad key to select a numbered menu item. Press 2 to view the **Status** menu, for example.
  - Press **SELECT** or an appropriate soft key to save changes.
  - Press **CANCEL** to cancel an operation, exit the menu display or return to the idle screen.

## Using the Status menu

Use the **Status** menu to verify network settings and begin troubleshooting if network problems or account registration issues affect operation.

You can also find the software version of the C520 on the **Product Info** screen, available from the **Status** menu.

### *To view the Status menu:*

1. When the C520 is idle, press **MENU**.
2. On the **Main Menu**, press **▲** or **▼** to highlight **Status**, and then press **SELECT**.  
The **Status** menu appears.

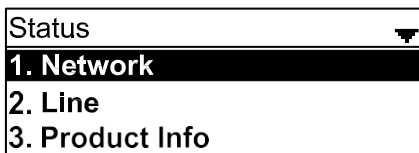

3. On the **Status** menu, press **▲** or **▼** to highlight the desired menu, and then press **SELECT**.

The available status menus are listed in Table 3.

**Table 3. Status menu summary**

Menu	Information listed
1. Network	<ul style="list-style-type: none"> <li>■ IP address</li> <li>■ DHCP status (Enabled/Disabled)</li> <li>■ Subnet Mask</li> <li>■ Gateway IP address</li> <li>■ DNS server 1 IP address</li> <li>■ DNS server 2 IP address</li> <li>■ SNTP server URL</li> <li>■ MAC address</li> </ul>
2. Line	<p>Lines and registration status. On the <b>Line</b> menu, highlight and select the desired line to view detailed line status information:</p> <ul style="list-style-type: none"> <li>■ Line status (Registered/Not registered)</li> <li>■ Account display name</li> <li>■ Account User ID</li> <li>■ Registrar Server IP address</li> <li>■ Registrar Server port number</li> <li>■ Proxy server IP address</li> <li>■ Proxy server port number</li> </ul>
3. Product Info	<ul style="list-style-type: none"> <li>■ Model number</li> <li>■ Serial number</li> <li>■ MAC address</li> <li>■ Boot version</li> <li>■ Firmware version</li> <li>■ V-Series</li> <li>■ Hardware version</li> <li>■ EMC version</li> </ul>

## Viewing Line status

To view line status, from the **Status** menu, select **Line**. The **Line** menu lists the available lines, along with icons indicating each line's current registration status.

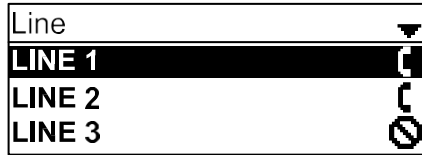



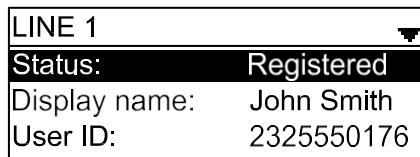

Table 4. Line status icons

Icon	Description
	Line registered
	Line unregistered
	Line disabled

### To view complete status information for a line:

- On the **Line** menu, press ▲ or ▼ to highlight the desired line, and then press **SELECT**. The full line status screen appears.



## Using the Admin Settings Menu

### To access the Admin Settings menu:

1. When the C520 is idle, press **MENU**.  
The **Main Menu** appears.

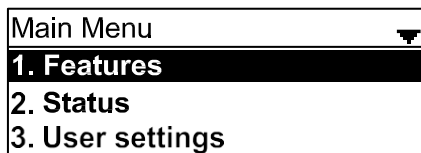

2. Press **▲** or **▼** to highlight **Admin settings**, and then press **SELECT**.

-or-

Press 4 (**Admin settings**) on the dial pad.

3. Use the dial pad to enter the admin password, and then press **Enter**. The default password is **admin** (press the **123** soft key to switch between text input options—lowercase letters, uppercase letters, and numbers).

The Admin settings are listed in Table 5.

**Table 5. Admin setting summary**

Setting	Options
1. Network setting	1. DHCP (Enabled, Disabled) 2. Set static IP 3. VLAN ID 4. Others
2. Line	1. LINE 1 2. LINE 2 3. LINE 3
3. Provisioning	1. Server 2. Login 3. Password
4. Reset to default	Press <b>SELECT</b> to display a screen that allows you to reset the phone to factory default settings.
5. Restart phone	Press <b>SELECT</b> to display a screen that allows you to restart the phone.



## Using the Network Setting menu

Use the Network setting menu to configure network-related settings for the C520. For more information about these settings, see “Basic Network Settings” on page 55 and “Advanced Network Settings” on page 56.

### To use the Network setting menu:

- From the **Admin Settings** menu, press ▲ or ▼ to highlight **Network setting**, and then press **SELECT**.  
The **Network setting** menu appears.

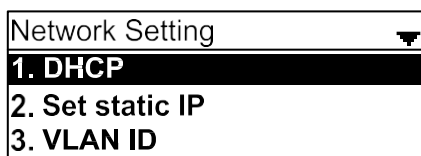

- Press ▲ or ▼ to highlight the desired option, and then press **SELECT**:
  - DHCP
  - Set static IP
  - VLAN ID
  - Others (DNS and NTP servers).

### To enable or disable DHCP:

- From the **Network setting** menu, press ▲ or ▼ to highlight **DHCP**, and then press **SELECT**.  
The **DHCP** screen appears.

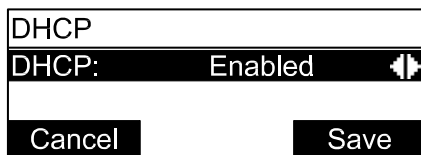

- Press ◀ or ▶ to select **Enabled** or **Disabled**, and then press **Save**.

DHCP is enabled by default, which means the C520 will get its IP address from the network. When DHCP is disabled, you must enter a static IP address for the C520.



**NOTE**

You must be familiar with TCP/IP principles and protocols to configure static IP settings.

**To set static IP for the C520:**

1. From the **Network setting** menu, press ▲ or ▼ to highlight **Set static IP**, and then press **SELECT**.

If DHCP is disabled, the **Set static IP** menu appears. If DHCP is enabled, an error message appears briefly before returning you to the **Network setting** menu.

2. On the **Set static IP** menu, enter the static IP address. Use the dial pad and the **Add dot** soft key to enter characters. Press ◀ or ▶ to advance to the next character.

Set static IP	
IP:	192.168.0.
Subnet Mask:	255.255.255.0
Backspc	Add dot Save

3. Press ▼ and enter the Subnet Mask. Use the dial pad and the **Add dot** soft key to enter characters. Press ◀ or ▶ to advance to the next character.
4. Press ▼ and enter the Gateway. Use the dial pad and the **Add dot** soft key to enter characters. Press ◀ or ▶ to advance to the next character.
5. Press **Save**.

**To set the VLAN ID for the C520:**

1. From the **Network setting** menu, press ▲ or ▼ to highlight **VLAN ID**, and then press **SELECT**.
2. On the **VLAN ID** menu, press ◀ or ▶ to enable or disable the WAN VLAN.

VLAN ID	
WAN Vlan:	Disabled
WAN port:	0
Cancel	Save

3. Press ▼ and enter the WAN VID. Use the dial pad and the **Backspc** soft key to enter characters. The valid range is 0 to 4095.
4. Press **Save**.

**To set other settings (DNS and NTP):**

1. From the **Network setting** menu, press ▲ or ▼ to highlight **Others**, and then press **SELECT**.

If DHCP is disabled, the **Others** menu appears. If DHCP is enabled, an error message appears briefly before returning you to the **Network setting** menu.

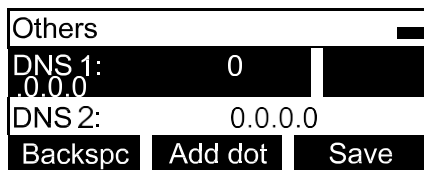

2. Enter the IP address for the primary DNS server. Use the dial pad and the **Add dot** soft key to enter characters. Press ◀ or ▶ to advance to the next character.
3. Press ▼ and enter the IP address for the secondary DNS server. The C520 uses this server if the primary server does not respond.
4. Press ▼ and enter the IP address for the NTP server. If the C520 does not use an NTP server, you must manually enter the time and date settings.
5. Press **Save** .

## Using the Line menu

Use the **Line** menu to configure line-specific settings for the phone.

### To use the Line setting menu:

1. From the **Admin Settings** menu, press ▼ to highlight **Line**, and then press **SELECT**. The **Line** menu appears.

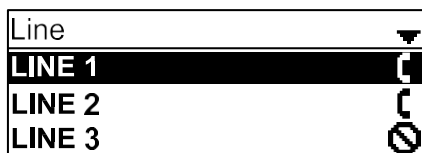

2. Highlight the desired line, if necessary, by pressing ▼, and then press **SELECT**. The full configuration menu for that line appears.

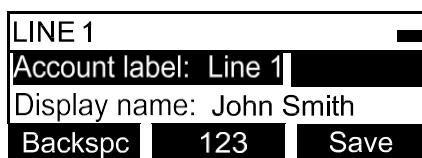

You can configure:

- Account label
- Display name
- User ID
- Authorization ID
- Authorization Password
- SIP Registrar Server IP
- Registrar Server port
- Proxy server IP
- Proxy server port
- Register (Yes or No)
- Answer page (Manual or Auto)

For more information about these settings, see *“SIP Account Management” on page 34*.

3. Edit the Line settings using the dial pad and the soft keys available for each setting:
  - **Backspc** —deletes a character
  - **123** —enables you to enter numbers, lower case letters, or upper case letters using the dial pad. The soft key does not appear when the setting accepts numbers only.
  - **Save** —saves and applies the new settings
  - **Edit** —enables you to edit the setting (appears for the Password setting)
4. Press ◀ or ▶ to advance to the next character.

## Using the Provisioning menu

Use the Provisioning menu to configure auto-provisioning settings. For more information about auto-provisioning, see “Provisioning” on page 74 and “Provisioning Using Configuration Files” on page 85.

On the Provisioning menu you can configure:

- Server string—the URL of the provisioning server. The URL can include a complete path to the configuration file.
- Login ID—the username the C520 will use to access the provisioning server.
- Login PW—the password the C520 will use to access the provisioning server.

### To use the Provisioning menu:

1. From the **Admin Settings** menu, press ▼ to highlight **Provisioning**, and then press **SELECT**.  
The **Provisioning** menu appears.

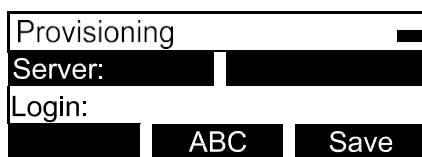

The screenshot shows a menu titled "Provisioning" with a small arrow icon on the right. Below the title are two input fields: "Server:" and "Login:". At the bottom of the menu are three buttons: "ABC", "Save", and a partially visible "Edit" button.

2. Enter the server URL using the dial pad keys:
  - **Backspc**—deletes a character
  - **ABC**—enables you to enter numbers, lower case letters, or upper case letters with the dial pad. Does not appear when the setting accepts numbers only.
  - **Save**—prompts you to reboot the phone and apply the new settings
  - **Edit**—enables you to edit the setting (appears for the Password setting)

The format of the URL must be RFC 1738 compliant, as follows:

"<schema>://<user>:<password>@<host>:<port>/<url-path>"

"<user>:<password>@" may be empty.

"<port>" can be omitted if you do not need to specify the port number.

3. Press ▼ to move to the next line and enter the Login ID for access to the provisioning server if it is not part of the server string.
4. Press ▼ to move to the next line and enter the Login password.
5. Press **Save** .

## CHAPTER 3

# USING THE WEBUI

The WebUI allows you to configure all aspects of C520 conference phone operation, including account settings, network settings, contact lists, and provisioning settings. The WebUI is embedded in the C520 operating system. When you access the WebUI, you are accessing it on the device, not on the Internet.

This chapter describes how to access the WebUI and configure C520 settings. This chapter covers:

- *“Using the Web User Interface (WebUI)” on page 31*
- *“Status Page” on page 33*
- *“System Pages” on page 34*
- *“Network Pages” on page 55*
- *“Contacts Pages” on page 58*
- *“Servicing Pages” on page 69.*

## Using the Web User Interface (WebUI)

The Web User Interface (WebUI) resides on the C520 conference phone. You can access it using an Internet browser. After you log in to the WebUI, you can configure the C520 on the following pages:

### System

- SIP Account Management (see *page 34*)
- Call Settings (see *page 45*)
- User Preferences (see *page 47*)
- Speed Dial (see *page 50*)
- Signaling Settings (see *page 52*)
- Ringer Settings (see *page 53*)

### Network

- Basic Network Settings (see *page 55*)
- Advanced Network Settings (see *page 56*)

### Contacts

- Local Directory (see *page 58*)
- Blacklist
- LDAP (see *page 64*)
- Broadsoft (see *page 67*)
- Call History (see *page 68*)

### Servicing

- Reboot (see *page 69*)
- Time and Date (see *page 69*)
- Firmware Upgrade (see *page 72*)
- Provisioning (see *page 74*)
- Security (see *page 80*)
- Certificates (see *page 81*)
- System Logs (see *page 83*)

The WebUI also has a **System Status** page, where you can view network status and general information about the C520. The information on the Status page matches the **Status** menu available on the C520.



**To access the WebUI:**

1. Ensure that your computer is connected to the same network as the C520.
2. Find the IP address of the C520:
  - a. When the C520 is idle, press **MENU**.
  - b. Press **▼** to highlight **Status**, and then press **SELECT**.
  - c. With **Network** highlighted, press **SELECT**.  
The **Network** status screen appears.
  - d. On the **Network** status screen, note the IP Address.

Network	
IP:	192.168.100.100
DHCP:	Enabled
Subnet Mask:	255.255.255.255

3. On your computer, open an Internet browser. (Depending on your browser, some of the pages presented here may look different and have different controls. Ensure that you are running the latest update of your preferred browser.)
4. Type the C520 IP address in the browser address bar and press **ENTER** on your computer keyboard.  
The browser displays a window asking for your user name and password.
5. For the user name, enter **admin**. For the password, enter the default password, **admin**. You can change the password later on the WebUI **Security** page, available under **Servicing**.
6. Click **OK**.  
The WebUI appears.

Click topics from the navigation bar along the top of the WebUI, and then click the links along the left to view individual pages. For your security, the WebUI times out after 10 minutes, so if it is idle for that time, you must log in again.

Most WebUI configuration pages have a  button. Click  to save changes you have made on the page. During a configuration session, click  before you move on to the next WebUI page.

The remaining procedures in this section assume that you are already logged into the WebUI.



**NOTE**

The settings tables in this section contain settings that appear in the WebUI and their equivalent settings in the configuration file template. You can use the configuration file template to create custom configuration files. Configuration files can be hosted on a provisioning server and used for automatically configuring phones. For more information, see *“Provisioning Using Configuration Files” on page 85*.

---



## Status Page

The WebUI System Status page is equivalent to the **Status** menu on the C520.

### System Status

The System Status page shows:

- **General** information about your device, including model, MAC address, and firmware version
- **Account Status** information about your SIP account registration
- **Network** information regarding your device's network address and network connection

The screenshot displays the 'STATUS' page in the WebUI. The left sidebar is blue with 'STATUS' at the top and 'System Status' selected below it. The main content area has a dark grey header with tabs for 'STATUS', 'SYSTEM', 'NETWORK', 'CONTACTS', and 'SERVICING'. The 'STATUS' tab is active, showing three sections: 'General', 'Account Status', and 'Network'. Each section lists various device and configuration parameters.

STATUS	SYSTEM	NETWORK	CONTACTS	SERVICING
<b>System Status</b>				
<b>General</b>				
Model:	VCS752			
Serial Number:	A5700002007			
MAC Address:	14:AE:DB:19:E3:A4			
Boot Version:	1.05			
Software Version:	1.1.5.D			
V-Series:	1.39.19-0-ENG			
Hardware Version:	HW1.0			
EMC Version:				
<b>Account Status</b>				
Account 1:	Registered			
Account 2:	Registered			
Account 3:	Not Registered			
<b>Network</b>				
LAN Port IP Address:	10.88.50.124			
IP Type:	DHCP			
Subnet Mask:	255.255.0.0			
Link Status:	Connected			
Gateway:	10.88.3.149			
Primary DNS:	10.88.162.10			
Secondary DNS:	10.88.162.6			
Network Time Settings:	us.pool.ntp.org			

## System Pages

### SIP Account Management

On the SIP Account Management pages, you can configure each account you have ordered from your service provider.

The SIP Account settings are also available as parameters in the configuration file. See *“sip\_account” Module: SIP Account Settings* on page 94.

### General Account Settings

SYSTEM	STATUS	SYSTEM	NETWORK	CONTACTS	SERVICING
SIP Account Management	<b>SYSTEM ACCOUNT MANAGEMENT ACCOUNT 1</b>				
Account 1	<b>General Account Settings</b>				
Account 2	<input checked="" type="checkbox"/> Enable Account				
Account 3	Account Label:	<input type="text" value="Line 1"/>			
Call Settings	Display Name:	<input type="text" value="John Smith"/>			
Account 1	User Identifier:	<input type="text" value="203"/>			
Account 2	Authentication Name:	<input type="text" value="203"/>			
Account 3	Authentication Password:	<input type="password" value="....."/>			
User Preferences	Dial Plan:	<input type="text" value="x+P"/>			
Programmable Keys	Inter-Digit Timeout (secs):	<input type="text" value="3"/>			
Program Dial 1	Maximum Number of Calls:	<input type="text" value="6"/>			
Program Dial 2	Page Auto Answer:	<input type="text" value="Manual"/>			
Program Dial 3	Feature Synchronization:	<input type="text" value="Disable"/>			
Speed Dial	DTMF Method:	<input type="text" value="Auto"/>			
Signaling	Unregister After Reboot:	<input type="text" value="Disable"/>			
Ringer					
Paging Zones					

Click the link for each setting to see the matching configuration file parameter in *“Configuration File Parameter Guide”* on page 93. Default values and ranges are listed there.

Setting	Description
Enable Account	Enable or disable the SIP account. Select to enable.
Account Label	Enter the name that will appear on the C520 display when account x is selected.
Display Name	Enter the Display Name. The Display Name is the text portion of the caller ID that is displayed for outgoing calls using account x.
User identifier	Enter the User identifier supplied by your service provider. The User ID, also known as the Account ID, is a SIP URI field used for SIP registration. <b>Note:</b> Do not enter the host name (e.g. "@sipservice.com"). The WebUI automatically adds the default host name.

Setting	Description
Authentication name	If authentication is enabled on the server, enter the authentication name (or authentication ID) for authentication with the server.
Authentication password	If authentication is enabled on the server, enter the authentication password for authentication with the server.
Dial Plan	Enter the dial plan, with dialing strings separated by a   symbol. See <i>"Dial Plan"</i> on page 36.
Inter Digit Timeout (secs)	Sets how long the C520 waits after any "P" (pause) in the dial string or in the dial plan.
Maximum Number of Calls	Select the maximum number of concurrent active calls allowed for that account.
Page Auto Answer	When set to Auto, enables the C520 to automatically answer when a page is received. This is usually the desired behavior for paging.
Feature Synchronization	Enables the C520 to synchronize with BroadWorks Application Server. Changes to features such as DND, Call Forward All, Call Forward No Answer, and Call Forward Busy on the server side will also update the settings on the C520 menu and WebUI. Similarly, changes made using the C520 or WebUI will update the settings on the server.
DTMF method	Select the default DTMF transmission method. You may need to adjust this if call quality problems are triggering unwanted DTMF tones or you have problems sending DTMF tones in general.
Unregister after reboot	Enables the phone to unregister the account(s) after rebooting-before the account(s) register again as the phone starts up. If other phones that share the same account(s) unregister unexpectedly in tandem with the rebooting C520, disable this setting.

## Dial Plan

The dial plan consists of a series of dialing rules, or strings, that determine whether what the user has dialed is valid and when the C520 should dial the number.



Numbers that are dialed when forwarding a call—when the user manually forwards a call, or a pre-configured number is dialed for Call Forward All, Call Forward–No Answer, or Call Forward Busy—always bypass the dial plan.

Dialing rules must consist of the elements defined in the table below.

Element	Description
x	Any dial pad key from 0 to 9, including # and *.
[0-9]	Any two numbers separated by a hyphen, where the second number is greater than the first. All numbers within the range or valid, excluding # and *.
x+	An unlimited series of digits.
,	This represents the playing of a secondary dial tone after the user enters the digit(s) specified or dials an external call prefix before the comma. For instance, "9,xxxxxx" means the secondary dial tone is played after the user dials 9 until any new digit is entered. "9,3xxxxxx" means only when the digit 3 is hit would the secondary dial tone stop playing.
PX	This represents a pause of a defined time; X is the pause duration in seconds. For instance, "P3" would represent pause duration of 3 seconds. When "P" only is used, the pause time is the same as the Inter Digit Timeout (see "SIP Account Management" on page 34).
(0:9)	This is a substitution rule where the first number is replaced by the second. For example, "(4:723)xxxx" would replace "46789" with "723-6789". If the substituted number (the first number) is empty, the second number is added to the number dialed. For example, in "( :1)xxxxxxxx", the digit 1 is appended to any 10-digit number dialed.
	This separator is used to indicate the start of a new pattern. Can be used to add multiple dialing rules to one pattern edit box.

A sample dial plan appears below.

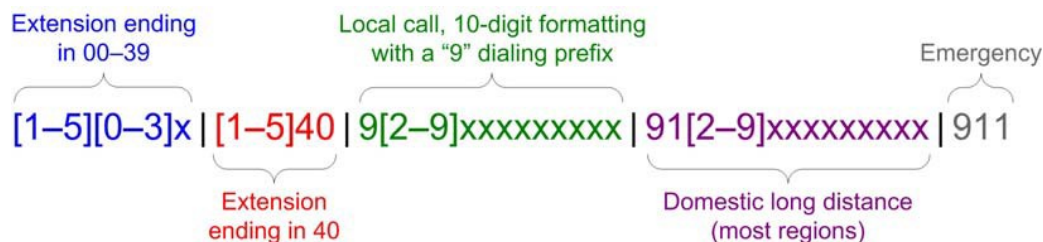

## SIP Server Settings

	<b>SIP Server</b>	
	Server Address:	<input type="text" value="10.88.25.60"/>
	Port:	<input type="text" value="5060"/>

Setting	Description
Server address	Enter the IP address or domain name for the SIP server.
Server port	Enter the port number that the SIP server will use.

## Registration Settings

	<b>Registration</b>	
	Server Address:	<input type="text" value="10.88.25.60"/>
	Port:	<input type="text" value="5060"/>
	Expiration (secs):	<input type="text" value="3600"/>
	Registration Freq (secs):	<input type="text" value="10"/>

Setting	Description
Server address	Enter the IP address or domain name for the registrar server.
Server port	Enter the port number that the registrar server will use.
Expiration	Enter the desired registration expiry time in seconds.
Registration Freq (secs)	Enter the desired registration retry frequency in seconds. If registration using the Primary Outbound Proxy fails, the Registration Freq setting determines the number of seconds before a registration attempt is made using the Backup Outbound Proxy.

## Outbound Proxy Settings

	<b>Outbound Proxy</b>	
	Server Address:	<input type="text"/>
	Port:	<input type="text" value="5060"/>

Setting	Description
Server address	Enter the IP address or domain name for the proxy server.
Server port	Enter the port number that the proxy server will use.

## Backup Outbound Proxy Settings

	<p><b>Backup Outbound Proxy</b></p> <p>Server Address: <input type="text"/></p> <p>Port: <input type="text" value="5060"/></p>
--	--

Setting	Description
Server address	Enter the IP address or domain name for the backup proxy server.
Server port	Enter the port number that the backup proxy server will use.

## Audio Settings

	<p><b>Audio</b></p> <p>Ringer Tone: <input type="text" value="1"/></p> <p>Codec Priority 1: <input type="text" value="G.711u"/></p> <p>Codec Priority 2: <input type="text" value="G.711a"/></p> <p>Codec Priority 3: <input type="text" value="G.729a/b"/></p> <p>Codec Priority 4: <input type="text" value="G.726"/></p> <p>Codec Priority 5: <input type="text" value="G.722"/></p> <p><input type="checkbox"/> Enable Voice Encryption (SRTP)</p> <p><input type="checkbox"/> Enable G.729 Annex B</p> <p>Preferred Packetization Time (ms): <input type="text" value="20"/></p>
--	---

Setting	Description
Ringer Tone	Sets the ringer tone for incoming calls on the account.
Codec priority 1	Select the codec to be used first during a call.
Codec priority 2	Select the codec to be used second during a call if the previous codec fails.
Codec priority 3	Select the codec to be used third during a call if the previous codec fails.
Codec priority 4	Select the codec to be used fourth during a call if the previous codec fails.
Codec priority 5	Select the codec to be used fifth during a call if the previous codec fails.
Enable voice encryption (SRTP)	Select to enable secure RTP for voice packets.
Enable G.729 Annex B	When G.729a/b is enabled, select to enable G.729 Annex B, with voice activity detection (VAD) and bandwidth-conserving silence suppression.
Preferred Packetization Time (ms)	Select the packetization interval time.

## Quality of Service

	<b>Quality of Service</b>
	DSCP (voice): <input type="text" value="46"/>
	DSCP (signaling): <input type="text" value="26"/>

Setting	Description
DSCP (voice)	Enter the Differentiated Services Code Point (DSCP) value from the Quality of Service setting on your router or switch.
DSCP (signalling)	Enter the Differentiated Services Code Point (DSCP) value from the Quality of Service setting on your router or switch.

## Signaling Settings

	<b>Signaling Settings</b>
	Local SIP Port: <input type="text" value="5060"/>
	Transport: <input type="text" value="UDP"/>

Setting	Description
Local SIP port	Enter the local SIP port.
Transport	<p>Select the SIP transport protocol:</p> <ul style="list-style-type: none"> <li>■ TCP (Transmission Control Protocol) is the most reliable protocol and includes error checking and delivery validation.</li> <li>■ UDP (User Datagram Protocol) is generally less prone to latency, but SIP data may be subject to network congestion.</li> <li>■ TLS (Transport Layer Security)—the C520 supports secured SIP signalling via TLS. Optional server authentication is supported via user-uploaded certificates. TLS certificates are uploaded using the configuration file. See <i>“file” Module: Imported File Settings</i> on page 135 and consult your service provider.</li> </ul>

## Feature Access Codes Settings

If your IP PBX service provider uses feature access codes, then enter the applicable codes here.

Feature Access Codes	
Paging:	<input type="text"/>
Call Park:	<input type="text"/>
Parked Call Retrieval:	<input type="text"/>
Voicemail:	<input type="text"/>
DND ON:	<input type="text"/>
DND OFF:	<input type="text"/>
Call Forward All ON:	<input type="text"/>
Call Forward All OFF:	<input type="text"/>
Call Forward No Answer ON:	<input type="text"/>
Call Forward No Answer OFF:	<input type="text"/>
Call Forward Busy ON:	<input type="text"/>
Call Forward Busy OFF:	<input type="text"/>
Anonymous Call Reject ON:	<input type="text"/>
Anonymous Call Reject OFF:	<input type="text"/>
Anonymous Call ON:	<input type="text"/>
Anonymous Call OFF:	<input type="text"/>
Call Waiting ON:	<input type="text"/>
Call Waiting OFF:	<input type="text"/>
Group Call Pickup:	<input type="text"/>
Direct Call Pick Up:	<input type="text"/>

Setting	Description
Paging	Enter the paging access code.
Call Park	Enter the call park access code. Broadsoft provides a feature access code for the park feature. Asterisk/Metaswitch provides a parking lot extension number for the park feature. Enter the parking lot extension number here.
Parked Call Retrieval	Enter the call park retrieval access code. Broadsoft and Asterisk/Metaswitch provide a feature access code for park retrieval.
Voicemail	Enter the voicemail access code. The code is dialed when the user selects a line from the phone's Message menu.
DND ON	Enter the Do Not Disturb ON access code.
DND OFF	Enter the Do Not Disturb OFF access code.
Call Forward All ON	Enter the Call Forward All ON access code.
Call Forward All OFF	Enter the Call Forward All OFF access code.
Call Forward No Answer ON	Enter the Call Forward No Answer ON access code.
Call Forward No Answer OFF	Enter the Call Forward No Answer OFF access code.



Setting	Description
Call Forward Busy ON	Enter the Call Forward Busy ON access code.
Call Forward Busy OFF	Enter the Call Forward Busy OFF access code.
Anonymous Call Reject ON	Enter the Anonymous Call Reject ON access code.
Anonymous Call Reject OFF	Enter the Anonymous Call Reject OFF access code.
Anonymous Call ON	Enter the Anonymous Call ON access code.
Anonymous Call OFF	Enter the Anonymous Call OFF access code.
Call Waiting ON	Enter the Call Waiting ON access code.
Call Waiting OFF	Enter the Call Waiting OFF access code.
Group Call Pickup	Enter the Group Call Pickup code. Dialing the code enables the user to answer a call ringing at another C520 that is part of the same group.
Direct Call Pickup	Enter the Direct Call Pickup code. Dialing the code enables the user to answer a call ringing at another C520.

## Voicemail Settings

**Voicemail Settings**

Enable MWI Subscription

Mailbox ID:

Expiration (secs):

Ignore Unsolicited MWI

Enable Stutter Dial Tone

Setting	Description
Enable MWI Subscription	When enabled, the account subscribes to the "message summary" event package. The account may use the User ID or the service provider's "Mailbox ID".
Mailbox ID	Enter the URI for the mailbox ID. The phone uses this URI for the MWI subscription. If left blank, the User ID is used for the MWI subscription.
MWI subscription expiration	Enter the MWI subscription expiry time (in seconds) for account x.
Ignore unsolicited MWI	<p>When selected, unsolicited MWI notifications—notifications in addition to, or instead of SUBSCRIBE and NOTIFY methods—are ignored for account x. If the C520 receives unsolicited MWI notifications, the Message Waiting LED will not light to indicate new messages.</p> <p>Disable this setting if:</p> <ul style="list-style-type: none"> <li>■ MWI service does not involve a subscription to a voicemail server. That is, the server supports unsolicited MWI notifications.</li> <li>■ you want the Message Waiting LED to indicate new messages when the C520 receives unsolicited MWI notifications.</li> </ul>
Enable Stutter Dial Tone	Enables or disables the stutter dial tone for that account (indicating message(s) waiting) when the phone goes off hook.

## NAT Traversal

	<p><b>NAT Traversal</b></p> <p><input type="checkbox"/> Enable STUN</p> <p>Server Address: <input type="text"/></p> <p>Port: <input type="text" value="3478"/></p> <p><input checked="" type="checkbox"/> Enable UDP Keep-Alive</p> <p>Keep-Alive Interval (secs): <input type="text" value="30"/></p>
--	--

Setting	Description
Enable STUN	Enables or disables STUN (Simple Traversal of UDP through NATs) for account x. The Enable STUN setting allows the C520 to identify its publicly addressable information behind a NAT via communicating with a STUN server.
Server address	Enter the STUN server IP address or domain name.
Server port	Enter the STUN server port.
Enable UDP Keep-Alive	Enables or disables UDP keep-alives. Keep-alive packets are used to maintain connections established through NAT.
Keep-alive interval (secs)	Enter the interval (in seconds) for sending UDP keep-alives.

## Music on Hold Settings

	<p><b>Music On Hold</b></p> <p><input type="checkbox"/> Enable Local MoH</p>
--	--

Setting	Description
Enable Local MoH	Enables or disables a hold-reminder tone that the user hears when a far-end caller puts the call on hold.

## Network Conference Settings

	<p><b>Network Conference</b></p> <p><input type="checkbox"/> Enable Network Conference</p> <p>Conference URI: <input type="text"/></p>
--	--

Setting	Description
Enable Network Conference	Enables or disables network conferencing for account x.
Conference URI	Enter the URI for the network bridge for conference handling on account x.

## Session Timer

**Session Timer**

Enable Session Timer

Minimum value (secs):

Maximum value (secs):

Setting	Description
Enable Session Timer	Enables or disables the SIP session timer. The session timer allows a periodic refreshing of a SIP session using the RE-INVITE message.
Minimum value (secs)	Sets the session timer minimum value (in seconds) for account x.
Maximum value (secs)	Sets the session timer maximum value (in seconds) for account x.

## Call Settings

You can configure call settings for each account. Call Settings include Do Not Disturb and Call Forward settings.

The call settings are also available as parameters in the configuration file. See *“call\_settings” Module: Call Settings* on page 131.

### General Call Settings

Setting	Description
Anonymous Call Reject	Enables or disables rejecting calls indicated as "Anonymous."
Enable Anonymous Call	Enables or disables outgoing anonymous calls. When enabled, the caller name and number are indicated as "Anonymous."

### Do Not Disturb

Setting	Description
Enable DND	Turns Do Not Disturb on or off.
Incoming calls	When set to Show, the phone displays incoming call information while Do Not Disturb is on. When set to Reject, the phone rejects incoming calls without alerting the user.

## Call Forward

Setting	Description
Enable Call Forward Always	Enables or disables call forwarding for all calls on that line. Select to enable.
Target Number	Enter a number to which all calls will be forwarded.
Enable Call Forward Busy	Enables or disables forwarding incoming calls to the target number if: <ul style="list-style-type: none"> <li>■ the number of active calls has reached the maximum number of calls configured for account x</li> <li>■ Call Waiting Off is selected.</li> </ul>
Target Number	Enter a number to which calls will be forwarded when Call Forward Busy is enabled.
Enable Call Forward No Answer	Enables or disables call forwarding for unanswered calls on that line.
Target Number	Enter a number to which unanswered calls will be forwarded.
Delay	Select the number of rings before unanswered calls are forwarded.

## Preferences

On the Preferences page, you can configure some basic settings for the phone and set hold reminder and call waiting settings. The Preferences page is also available to phone users when they log on to the WebUI.

The preference settings are also available as parameters in the configuration file. See *“user\_pref” Module: User Preference Settings* on page 127.

The screenshot shows the 'User Preferences' section of the WebUI. The left sidebar lists various settings categories, with 'User Preferences' selected. The main content area is titled 'General User Settings' and includes the following options:

- WebUI Language:** English (dropdown)
- Phone Language:** English (dropdown)
- Backlight Timer (secs):** 30 (dropdown)
- Ringer Volume:** Off (dropdown)
- Call Hold Reminder:**
  - Enable Call Hold Reminder Tone
  - Tone Interval (secs):** 30 (dropdown)
- Call Waiting:**
  - Call Waiting Off: Reject Incoming Call if already on a Call
  - Call Waiting On: View Incoming Call if already on a Call
  - Enable Call Waiting Tone
  - Tone Interval (secs):** 30 (dropdown)

A 'Save' button is located at the bottom of the settings area.

### General User Settings

Click the link for each setting to see the matching configuration file parameter in *“Configuration File Parameter Guide”* on page 93. Default values and ranges are listed there.

Setting	Description
WebUI Language	Sets the language that appears on the WebUI.
Phone Language	Sets the language that appears on the phone. Other languages may be added in a future release.
Backlight Timer (secs)	Sets how long (in seconds) the screen backlight stays on after the last button press.
Ringer Volume	Sets the ringer volume for incoming calls. You can also use the VOLUME ▼ or ▲ keys on the C520.

### Call Hold Reminder

Setting	Description
Enable Call Hold Reminder Tone	Enables or disables the call hold reminder tone. Select to enable.
Tone Interval (secs)	Sets the interval for the call hold reminder tone, in seconds.

### Call Waiting

Setting	Description
Call Waiting Off	When selected, disables incoming call notifications when the user is already on a call. Incoming calls are rejected. Incoming callers hear a busy signal. When Call Waiting Off is selected, and Call Forward Busy is enabled, incoming calls are handled according to the Call Forward Busy setting.
Call Waiting On	When selected, enables incoming call notifications when the user is already on a call.
Enable Call Waiting Tone	Enables or disables the call waiting tone. Select to enable.
Tone Interval (secs)	Sets the interval for the call waiting tone, in seconds.



## Program Dial Keys

The Program Dial feature allows phone users to dial numbers with a single press of a soft key. On the Program Dial pages, you can configure up to three Program Dial keys. Each key requires a label (short enough to fit in the soft key's area), an account and number that the key will dial, a location where the key will fit between the other soft keys, and the call modes during which the key will appear.

The screenshot shows the 'Program Dial 1' configuration page. On the left is a blue sidebar menu with the following items: SYSTEM, SIP Account Management, Account 1, Account 2, Account 3, Call Settings, Account 1, Account 2, Account 3, User Preferences, Programmable Keys, Program Dial 1 (highlighted), Program Dial 2, Program Dial 3, Speed Dial, Signaling, Ringer, and Paging Zones. The main content area has a top navigation bar with tabs: STATUS, SYSTEM, NETWORK, CONTACTS, and SERVICING. Below the tabs, the page title is 'Program Dial 1'. The configuration fields are: 'Label' (text input), 'Value' (text input), 'Account' (dropdown menu showing 'Account 1'), 'Enable' (checkboxes for Idle mode, Active mode, Held mode, and Livedial mode), 'Mode' (checkboxes for Idle mode, Active mode, Held mode, and Livedial mode), and 'Insert Label Before' (dropdown menus for Idle mode (dir), Active mode (end), Held mode (end), and Livedial mode (backspc)). A 'Save' button is located at the bottom left of the configuration area.

### **To enter program dial soft keys:**

1. Enter the Program Dial key label. Labels that exceed the width of the soft key will end with ... when they appear on the phone.
2. Enter a value that the Program Dial key will dial.
3. Select an account that the Program Dial key will use.
4. Select the call modes for which you want the Program Dial key to appear.
5. Select the location for the Program Dial key for the selected call modes. You can place the key before another key, or place it last in the order.
6. Click .
7. Configure any additional Program Dial keys.

## Speed Dial

On the Speed Dial page, you can enter up to 10 speed dial numbers. For each speed dial number you enter, you must assign the account on which the number will be dialed out.

To dial a speed dial number, press and hold the dial pad key that matches the speed dial entry number.



This menu duplicates the speed dial menu on the phone (**Main Menu >**

**Features > Speed dial**). Entries that are entered and saved on the WebUI replace entries that were entered using the phone. Similarly, entries that are configured using the phone menu will update entries on the WebUI.

The speed dial key settings are also available as parameters in the configuration file. See *“speed\_dial” Module: Speed Dial Settings* on page 133.

After entering information on this page, click  to save it.

SYSTEM	STATUS	SYSTEM	NETWORK	CONTACTS	SERVICING																																												
	<b>SIP Account Management</b> Account 1 Account 2 Account 3 <b>Call Settings</b> Account 1 Account 2 Account 3 User Preferences Programmable Keys Program Dial 1 Program Dial 2 Program Dial 3 <b>Speed Dial</b> Signaling Ringer Paging Zones	<b>Speed Dial</b> <table border="1"> <thead> <tr> <th>Key</th> <th>Name</th> <th>Value</th> <th>Account</th> </tr> </thead> <tbody> <tr> <td>Key 1</td> <td>VSP735</td> <td>249</td> <td>Default</td> </tr> <tr> <td>Key 2</td> <td>VSP600</td> <td>275</td> <td>Default</td> </tr> <tr> <td>Key 3</td> <td></td> <td></td> <td>Default</td> </tr> <tr> <td>Key 4</td> <td></td> <td></td> <td>Default</td> </tr> <tr> <td>Key 5</td> <td></td> <td></td> <td>Default</td> </tr> <tr> <td>Key 6</td> <td></td> <td></td> <td>Default</td> </tr> <tr> <td>Key 7</td> <td></td> <td></td> <td>Default</td> </tr> <tr> <td>Key 8</td> <td></td> <td></td> <td>Default</td> </tr> <tr> <td>Key 9</td> <td></td> <td></td> <td>Default</td> </tr> <tr> <td>Key 0</td> <td></td> <td></td> <td>Default</td> </tr> </tbody> </table> <input type="button" value="Save"/>					Key	Name	Value	Account	Key 1	VSP735	249	Default	Key 2	VSP600	275	Default	Key 3			Default	Key 4			Default	Key 5			Default	Key 6			Default	Key 7			Default	Key 8			Default	Key 9			Default	Key 0		
Key	Name	Value	Account																																														
Key 1	VSP735	249	Default																																														
Key 2	VSP600	275	Default																																														
Key 3			Default																																														
Key 4			Default																																														
Key 5			Default																																														
Key 6			Default																																														
Key 7			Default																																														
Key 8			Default																																														
Key 9			Default																																														
Key 0			Default																																														

### To enter speed dial numbers:

1. In the **Name** column, enter the name associated with this speed-dial entry.
2. In the **Value** column, enter a phone number for the desired key.
3. In the **Account** column, select the account that this speed dial number will use.
4. Click .

## Speed Dial Keys

Click the link for each setting to see the matching configuration file parameter in *“speed\_dial” Module: Speed Dial Settings* on page 133.

Setting	Description
Name	The name associated with the speed dial entry.
Value	The phone number that the speed dial key dials when pressed and held.
Account	The SIP account that the phone will use to dial the number.

## Signaling Settings

The signaling settings are also available as parameters in the configuration file. See *“network” Module: Network Settings* on page 107.

After entering information on this page, click  to save it.

SYSTEM	STATUS	SYSTEM	NETWORK	CONTACTS	SERVICING
<b>SYSTEM</b> SIP Account Management Account 1 Account 2 Account 3 Call Settings Account 1 Account 2 Account 3 User Preferences Programmable Keys Program Dial 1 Program Dial 2 Program Dial 3 Speed Dial <b>Signaling</b> Ringer Paging Zones	<b>Voice</b> Min Local RTP Port: <input type="text" value="18000"/> Max Local RTP Port: <input type="text" value="19000"/> <b>NAT Traversal</b> <input type="checkbox"/> Enable IP Masquerading Public IP Address: <input type="text"/> Public SIP Port: <input type="text" value="5060"/> Min Public RTP Port: <input type="text" value="18000"/> Max Public RTP Port: <input type="text" value="19000"/> <input type="button" value="Save"/>				

### Voice

Click the link for each setting to see the matching configuration file parameter in *“network” Module: Network Settings* on page 107. Default values and ranges are listed there.

Setting	Description
Min Local RTP port	Enter the lower limit of the Real-time Transport Protocol (RTP) port range. RTP ports specify the minimum and maximum port values that the phone will use for RTP packets.
Max Local RTP port	Enter the upper limit of the RTP port range.

### NAT Traversal

The NAT Traversal settings are communicated to the VoIP server so that the C520 is reachable when connected to the Internet behind NAT.

Setting	Description
Enable IP Masquerading	Select to enable NAT traversal and IP masquerading.
Public IP address	Enter the external IP address of your router. This setting identifies the router's public address to the VoIP server.
Public SIP port	Enter the router port number being used for SIP. This setting identifies the router's port to the VoIP server.
Min Public RTP port	Enter the lower limit of the public RTP port range.
Max Public RTP port	Enter the upper limit of the RTP port range.

## Ringer Settings

The Ringer Settings enable you to provide a distinctive ringing feature via the custom Alert-Info header associated with an incoming call. This setting overrides the ringer tone you have set for the account. For example, you can set a unique ringer tone to alert the C520 user upon receiving any incoming calls tagged as "important" in the Alert-Info header.

The SIP Invite message contains an Alert-Info header that the phone checks in order to determine which ringer tone to play. The Alert-Info header format is as follows:

```
Alert-Info: info=info_text
```

If the header contains the "info" parameter, the phone attempts to match it to the Distinctive Ringing Text. If there is a match, the associated tone will play. If there is no match, the default tone for the account will play.

The matching is done on a "first match" basis. In the case of duplicate text strings, the ringer tone associated with the first matched entry in the Distinctive Ringing Text list will play.

The server-side configuration must be done with your service provider. The SIP Invite text ("Distinctive Ringing Text" on the Ringer WebUI page) must be entered in the format **ringerx**, where x is the ringer number from 1 to 10. For example, to match Ringer 1 enter **ringer1**.

The ringer settings are also available as parameters in the configuration file. See *"ringersetting" Module: Distinctive Ringer Settings* on page 134.

After entering information on this page, click Save to save it.

Setting	Description
Distinctive Ringing Text	Enter the text that will match the "info" parameter and play the ringer tone. The Distinctive Ringing Text must be in the format <b>ringerx</b> where x is the ringer tone 1 to 10.
Tone	Select the desired ringer from the list.

## Paging Zones

On the Paging Zones page, you can enter the multicast IP addresses that the phone will monitor. When a page is sent out using this multicast IP address, all phones that are programmed to monitor that IP address will receive the paging RTP stream and play the page on their speakerphone. You can also enable the phone to send out multicast pages using a particular multicast IP address.

You must first set up paging groups (each group consisting of a multicast paging IP address and assigned User IDs) on your SIP PBX. The C520 can monitor a maximum of 10 multicast IP addresses.

ID	Name	Multicast IP	Multicast Port	Priority	Enable Incoming Page
1	<input type="text"/>	<input type="text"/>	<input type="text"/>	5	<input checked="" type="checkbox"/>
2	<input type="text"/>	<input type="text"/>	<input type="text"/>	5	<input checked="" type="checkbox"/>
3	<input type="text"/>	<input type="text"/>	<input type="text"/>	5	<input checked="" type="checkbox"/>
4	<input type="text"/>	<input type="text"/>	<input type="text"/>	5	<input checked="" type="checkbox"/>
5	<input type="text"/>	<input type="text"/>	<input type="text"/>	5	<input checked="" type="checkbox"/>
6	<input type="text"/>	<input type="text"/>	<input type="text"/>	5	<input checked="" type="checkbox"/>
7	<input type="text"/>	<input type="text"/>	<input type="text"/>	5	<input checked="" type="checkbox"/>
8	<input type="text"/>	<input type="text"/>	<input type="text"/>	5	<input checked="" type="checkbox"/>
9	<input type="text"/>	<input type="text"/>	<input type="text"/>	5	<input checked="" type="checkbox"/>
10	<input type="text"/>	<input type="text"/>	<input type="text"/>	5	<input checked="" type="checkbox"/>

Setting	Description
Name	Enter the name of the paging zone. Names can be a maximum of 15 characters. The paging zone name is displayed on the LCD during incoming and outgoing multicast pages.
Multicast IP	Enter the paging zone multicast IP address. The IP address range for multicast addresses is 224.0.0.0–239.255.255.255.
Multicast Port	Enter the multicast port used by the multicast IP address. The valid port range is 1 to 65535.
Priority	Select the paging zone priority from 1 to 10. Zones with a priority higher than another zone can interrupt the lower-priority zone's active page. In addition, a call priority setting is available in the configuration file (page_zone.call_priority_threshold). This priority setting also ranges from 1 to 10 (2 is the default). If the paging zone priority is higher or equal to the call priority, then a multicast page can interrupt an active, dialing, or incoming call.
Enable Incoming Page	Select to enable the C520 to receive incoming pages for that paging zone. If the "Enable Incoming Page" checkbox is not selected, the phone will not listen for the multicast, but will still be able to broadcast an outgoing page.

## Network Pages

You can set up the C520 for your network configuration on the Network pages. Your service provider may require you to configure your network to be compatible with its service, and the C520 settings must match the network settings.

“network” Module: Network Settings” on page 107.

The network settings are also available as parameters in the configuration file. See

After entering information on this page, click  to save it.

### Basic Network Settings

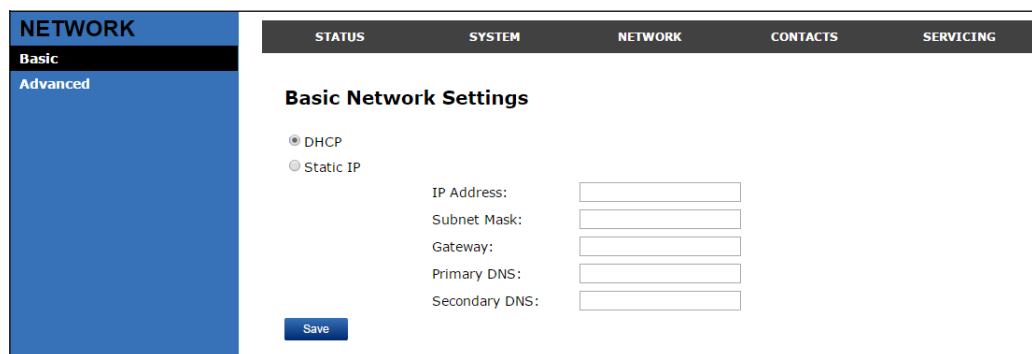

NOTE

If you disable DHCP on this page, you must configure static IP settings for the C520. You must be familiar with TCP/IP principles and protocols to configure static IP settings.

### Basic Network Settings

Click the link for each setting to see the matching configuration file parameter in “network” Module: Network Settings” on page 107. Default values and ranges are listed there.

Setting	Description
DHCP	DHCP is selected (enabled) by default, which means the C520 will get its IP address, Subnet Mask, Gateway, and DNS Server(s) from the network. When DHCP is disabled, you must enter a static IP address for the C520, as well as addresses for the Subnet Mask, Gateway, and DNS Server(s).
Static IP	When Static IP is selected, you must enter a static IP address for the C520, as well as addresses for the Subnet Mask, Gateway, and DNS Server(s).
IP Address	If DHCP is disabled, enter a static IP address for the C520.
Subnet Mask	Enter the subnet mask.
Gateway	Enter the address of the default gateway (in this case, your router).

Setting	Description
Primary DNS	If DHCP is disabled, enter addresses for the primary and secondary DNS servers.
Secondary DNS	

## Advanced Network Settings

### VLAN

You can organize your network and optimize VoIP performance by creating a virtual LAN for phones and related devices.

Click the link for each setting to see the matching configuration file parameter in *“network” Module: Network Settings* on page 107. Default values and ranges are listed there.

Setting	Description
Enable LAN Port VLAN	Enable if the phone is part of a VLAN on your network. Select to enable.
VID	Enter the VLAN ID (vlan 5, for example).
Priority	Select the VLAN priority that matches the Quality of Service (QoS) settings that you have set for that VLAN ID. Outbound SIP packets will be marked and sent according to their priority. 7 is the highest priority. <b>Note:</b> Configuring QoS settings for your router or switch is a subject outside the scope of this document.



## LLDP-MED

Setting	Description
Enable LLDP-MED	Enables or disables Link Layer Discovery Protocol for Media Endpoint Devices (LLDP-MED). LLDP-MED is a standards-based discovery protocol supported on some network switches. It is required for auto-configuration with VLAN settings.
Packet Interval (secs)	Sets the LLDP-MED packet interval (in seconds).

## 802.1x

Setting	Description
Enable 802.1x	Enables or disables the 802.1x authentication protocol. This protocol allows the phone to attach itself to network equipment that requires device authentication via 802.1x.
Identity	Enter the 802.1x EAPOL identity.
MD5 Password	Enter the 802.1x EAPOL MD5 password.

## Contacts Pages

### Local Directory

On the Local Directory page, you can manage your local directory entries. You can sort, edit, delete, and add contact information for up to 200 entries. In order to back up your contacts or import another local directory file, the page also enables you to export and import your phone's local directory.

The Local Directory lists entries on up to 10 pages, with 20 entries per page. Click [Next](#), [Last](#), [First](#), or a page number to view the desired page of entries.

CONTACTS
STATUS
SYSTEM
NETWORK
CONTACTS
SERVICING

**CONTACTS**

Local Directory

Blacklist

LDAP

Broadsoft

Call History

**Local Directory**

Select All  [Sort By Last Name](#)

Total: 21	First Name	Last Name	Ringer Tone	Home	Work	Mobile	Account	
<input type="checkbox"/>	Angela	Martin	0	<a href="#">7325550118</a>			1	<a href="#">Edit</a>
<input type="checkbox"/>	Bronwyn	McDonald	0	<a href="#">2325550140</a>			1	<a href="#">Edit</a>
<input type="checkbox"/>	Charlie	Johnson	0	<a href="#">5550198</a>			1	<a href="#">Edit</a>
<input type="checkbox"/>	Dale	Appleton	0		<a href="#">6045550135</a>		1	<a href="#">Edit</a>
<input type="checkbox"/>	David	Carter	3	<a href="#">2325550194</a>	<a href="#">2325550177</a>		2	<a href="#">Edit</a>
<input type="checkbox"/>	Davis	Swerdlow	0		<a href="#">2325550172</a>		1	<a href="#">Edit</a>
<input type="checkbox"/>	Elkhart	Taxi	0		<a href="#">6045550156</a>		1	<a href="#">Edit</a>
<input type="checkbox"/>	Graham	Ball	0		<a href="#">2325550176</a>		1	<a href="#">Edit</a>
<input type="checkbox"/>	Kathryn	Dolphy	0		<a href="#">6045550195</a>		1	<a href="#">Edit</a>
<input type="checkbox"/>	Linda	Miller	0		<a href="#">6045550117</a>		2	<a href="#">Edit</a>
<input type="checkbox"/>	Lydia	Braithwaite	0	<a href="#">2325550157</a>			1	<a href="#">Edit</a>
<input type="checkbox"/>	Martin	Meyers	0	<a href="#">2325550122</a>			1	<a href="#">Edit</a>
<input type="checkbox"/>	Mary	Williams	0		<a href="#">6045550145</a>	<a href="#">6045550146</a>	1	<a href="#">Edit</a>
<input type="checkbox"/>	Richard	Serling	0		<a href="#">6045550141</a>	<a href="#">7875550181</a>	2	<a href="#">Edit</a>
<input type="checkbox"/>	Robert	Brown	2		<a href="#">6045550105</a>		2	<a href="#">Edit</a>
<input type="checkbox"/>	Sandro	Voss	0	<a href="#">2325550149</a>			1	<a href="#">Edit</a>
<input type="checkbox"/>	Stefan	Wheeler	0		<a href="#">2325550161</a>		1	<a href="#">Edit</a>
<input type="checkbox"/>	Susan	Ballance	0		<a href="#">6045550170</a>		1	<a href="#">Edit</a>
<input type="checkbox"/>	Terry	Ng	0		<a href="#">2325550187</a>		1	<a href="#">Edit</a>
<input type="checkbox"/>	Ursula	Baldwin	0	<a href="#">6045550166</a>			1	<a href="#">Edit</a>

First **1** [Next](#) [Last](#)

[Delete Selected Entries](#)
[Add New Entry](#)
[Clear Directory](#)

**Import Local Directory**

[Choose File](#)









**Export Local Directory**



**NOTE** You can also use the phone menu to manage local directory entries. For more information, see the C520 User Manual.

Table 6 describes the buttons available on the Local Directory page.

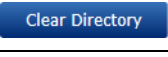
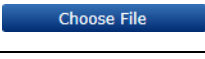
**Table 6. Local Directory commands**

Click	To...
	Sort the list by last name.
	Edit information for an entry
	View the next page of entries.
	View the last page of entries.
	View the first page of entries.
	Delete selected entries from the directory. Click <b>Select All</b> to select every entry on the page you are viewing.
	Add a new directory entry.
	Delete all Directory entries.
	Import a directory file.
	Export the directory.

**To add a new directory entry:**

1. Click  .  
The **Create Local Directory Entry** page appears.

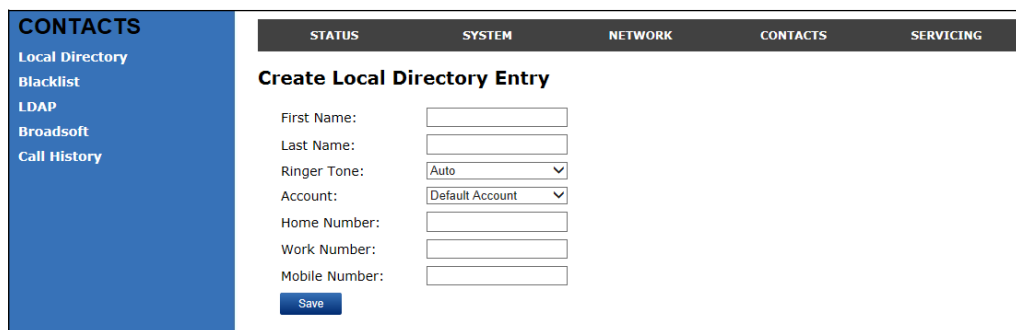

2. Enter the required information as described in the following table.

## Create Local Directory Entry

Setting	Description	Range	Default
First Name	Enter the appropriate names in these fields. The maximum length of the first name and last name fields is 15 characters.	n/a	Blank
Last Name			
Ringer Tone	Sets a unique ringer tone for calls from this directory entry.	Auto, Tone 1–10	Tone 1
Account	Sets the account used when you dial this directory entry.	Default Account, Account 1–3	Default Account
Work Number	Enter the appropriate names and numbers in these fields.	n/a	Blank
Mobile Number			
Other Number			

## Directory Import/Export

The best way to create a directory file for import is to first export the directory from the phone. After exporting the file, open it in an .xml editor and add or modify entries.

Importing a directory file adds the imported directory entries to existing entries. Therefore, it is possible to have duplicate entries after importing a directory file. If you are importing a "complete" directory file with the aim of replacing the entire current directory, use **Select All** and  to clear the directory before importing the file.



NOTE



Using the configuration file, you can set whether an imported directory file adds to existing entries or replaces existing entries. See *“file” Module: Imported File Settings* on page 135.

Directory files are .xml files that have the following tags:

Local Directory WebUI field	Directory file XML tag
First Name	<DIR_ENTRY_NAME_FIRST>
Last Name	<DIR_ENTRY_NAME_LAST>
Work Number	<DIR_ENTRY_NUMBER_WORK>
Mobile Number	<DIR_ENTRY_NUMBER_MOBILE>
Other Number	<DIR_ENTRY_NUMBER_OTHER>
Account	<DIR_ENTRY_LINE_NUMBER>
Call Block (not on WebUI)	<DIR_ENTRY_BLOCK>
Ringer Tone	<DIR_ENTRY_RINGER>

## Blacklist

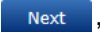
On the Blacklist page, you can manage local blacklist entries. The C520 rejects calls from numbers that match blacklist entries. You can sort, edit, delete, and add up to 200 blacklist entries. In order to back up your blacklist entries or import another local blacklist file, the page also enables you to export and import the blacklist.







The blacklist lists entries on up to 10 pages, with 20 entries per page. Click  ,  ,  , or a page number to view the desired page of entries.



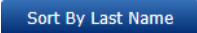



You can also use the C520 menu to manage blacklist entries. For more information, see the C520 User Manual.

Table 7 describes the buttons available on the Blacklist page.

**Table 7. Blacklist commands**

Click	To...
	Sort the list by last name.
	Edit information for an entry
	View the next page of entries.
	View the last page of entries.
	View the first page of entries.
	Delete selected entries. Click <b>Select All</b> to select every entry on the page you are viewing.

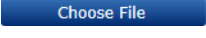
**Table 7. Blacklist commands**

Click	To...
	Add a new entry.
	Delete all entries.
	Import a blacklist file.
	Export the blacklist.

**To add a new blacklist entry:**

1. Click  .  
The **Create Blacklist Entry** page appears.

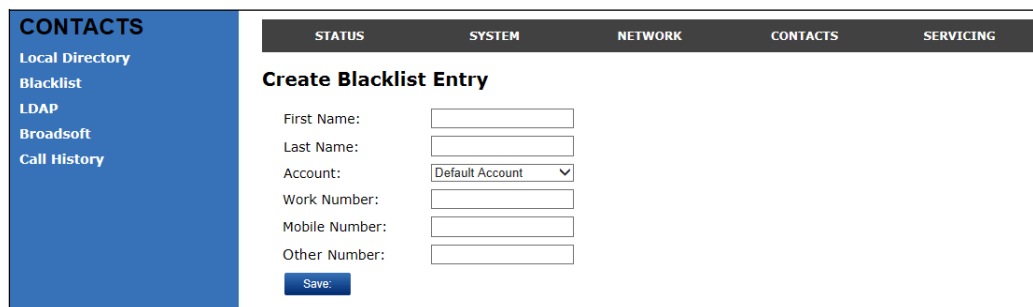

2. Enter the required information as described in the following table.

**Create Blacklist Entry**

Setting	Description	Range	Default
First Name	Enter the appropriate names in these fields. The maximum length of the first name and last name fields is 15 characters.	n/a	Blank
Last Name			
Account	Sets the account used when you dial this directory entry.	Default Account, Account 1–3	Account 1
Work Number	Enter the appropriate names and numbers in these fields.	n/a	Blank
Mobile Number			
Other Number			

## Blacklist Import/Export

The best way to create a blacklist file for import is to first export the blacklist from the C520. After exporting the file, open it in an .xml editor and add or modify entries.

Importing a blacklist file adds the imported blacklist entries to existing entries. Therefore, it is possible to have duplicate entries after importing a blacklist file. If you are importing a "complete" blacklist file with the aim of replacing the entire current blacklist, use **Select All** and  to clear the blacklist before importing the file.

**NOTE**

Using the configuration file, you can set whether an imported blacklist file adds to or replaces existing entries. See *“file” Module: Imported File Settings* on page 135.

Blacklist files are .xml files that have the following tags:

Blacklist WebUI field	Blacklist file XML tag
First Name	<BLACKLIST_ENTRY_NAME_FIRST>
Last Name	<BLACKLIST_ENTRY_NAME_LAST>
Work Number	<BLACKLIST_ENTRY_NUMBER_WORK>
Mobile Number	<BLACKLIST_ENTRY_NUMBER_MOBILE>
Other Number	<BLACKLIST_ENTRY_NUMBER_OTHER>
Account	<BLACKLIST_ENTRY_LINE_NUMBER>

## LDAP

The phone supports remote Lightweight Directory Access Protocol (LDAP) directories. An LDAP directory is hosted on a remote server and may be the central directory for a large organization spread across several cities, offices, and departments. You can configure the phone to access the directory and allow users to search the directory for names and telephone numbers.

The LDAP settings are also available as parameters in the configuration file. See *“remoteDir” Module: Remote Directory Settings* on page 121.

After entering information on this page, click **Save** to save it.

### LDAP Settings

Click the link for each setting to see the matching configuration file parameter in *“remoteDir” Module: Remote Directory Settings* on page 121. Default values and ranges are listed there.

Setting	Description
Enable LDAP	Enables or disables the phone's access to the LDAP directory.
Directory name	Enter the LDAP directory name.
Server address	Enter the LDAP server domain name or IP address.
Port	Enter the LDAP server port.



Setting	Description
Version	Select the LDAP protocol version supported on the phone. Ensure the protocol value matches the version assigned on the LDAP server.
Authentication scheme	Select the LDAP server authentication scheme.
Authentication name	Enter the user name or authentication name for LDAP server access.
Authentication password	Enter the authentication password for LDAP server access.
Base	Enter the LDAP search base. This sets where the search begins in the directory tree structure. Enter one of more attribute definitions, separated by commas (no spaces). Your directory may include attributes like "cn" (common name) or "ou" (organizational unit) or "dc" (domain component). For example: ou=accounting,dc=vtech,dc=com
Maximum number of entries	Sets the maximum number of entries returned for an LDAP search. Limiting the number of hits can conserve network bandwidth.
Maximum search delay	Enter the delay (in seconds) before the phone starts returning search results.
First name filter	Enter the first name attributes for LDAP searching. The format of the search filter is compliant to the standard string representations of LDAP search filters (RFC 2254).
Last name filter	Enter the last name attributes for LDAP searching. The format of the search filter is compliant to the standard string representations of LDAP search filters (RFC 2254).
Phone number filter	Enter the number attributes for LDAP searching. The format of the search filter is compliant to the standard string representations of LDAP search filters (RFC 2254).
First name attribute	Sets the attribute for first name. What you enter here should match the first name attribute for entries on the LDAP server (gn for givenName, for example). This helps ensure that the phone displays LDAP entries in the same format as the Local Directory.
Last name attribute	Sets the attribute for last name. What you enter here should match the last name attribute for entries on the LDAP server (sn for surname, for example). This helps ensure that the phone displays LDAP entries in the same format as the Local Directory.

Setting	Description
Work number attribute	Sets the attribute for the work number. What you enter here should match the work number attribute for entries on the LDAP server (telephoneNumber, for example). This helps ensure that the phone displays LDAP entries in the same format as the Local Directory.
Mobile number attribute	Sets the attribute for the mobile number. What you enter here should match the mobile number attribute for entries on the LDAP server (mobile, for example). This helps ensure that the phone displays LDAP entries in the same format as the Local Directory.
Other number attribute	Sets the attribute for the other number. What you enter here should match the other number attribute for entries on the LDAP server (otherPhone, for example). This helps ensure that the phone displays LDAP entries in the same format as the Local Directory.
Lookup for incoming calls	Enables or disables LDAP incoming call lookup. If enabled, the phone searches the LDAP directory for the incoming call number. If the number is found, the phone uses the LDAP entry for CID info.
Lookup in dialing mode	Enables or disables LDAP outgoing call lookup. If enabled, numbers entered in pre-dial or live dial are matched against LDAP entries. If a match is found, the LDAP entry is displayed for dialing.

## Broadsoft

The phone supports access to the Broadsoft Phonebook. Users can search for and call contacts that are hosted on the Broadsoft Phonebook. On the Broadsoft Phonebook Settings page, you must enter the path and credentials to enable the phone to access the Broadsoft Phonebook.

### Broadsoft Phonebook Settings

Setting	Description
Enable Broadsoft Phonebook	Enables or disables the phone's access to the Broadsoft phonebook.
Display name	Enter the display name for the Broadsoft Phonebook. This name appears on the Directory list on the C520 menu.
Server base address	Enter the Broadsoft Phonebook server domain or IP address.
Port	Enter the Broadsoft Phonebook server port.
Authentication name	Enter the user name or authentication name for Broadsoft Phonebook access.
Authentication password	Enter the authentication password for Broadsoft Phonebook access.
Directory type	Select the directory type: Group, Group Common, Enterprise, Enterprise Common, Personal

## Call History

The Call History page has no configurable settings. It displays Missed Calls, Received Calls, and Dialed Calls. Users can view their call history and "click to dial" numbers if click to dial is enabled.

**CONTACTS**

Local Directory

Blacklist

LDAP

Broadsoft

**Call History**

STATUS	SYSTEM	NETWORK	CONTACTS	SERVICING
--------	--------	---------	----------	-----------

### Call History

**Missed calls**

Date	Time	Name	Number	Account
2013-01-04	15:30:58	204	<a href="#">204</a>	1
2013-01-04	15:30:46	206	<a href="#">206</a>	1
2013-01-04	15:30:35	204	<a href="#">204</a>	1
2013-01-04	15:30:29	206	<a href="#">206</a>	1

**Received calls**

Date	Time	Name	Number	Account
2012-12-31	18:40:49	Ron Benoit	<a href="#">242</a>	1

**Dialed calls**

Date	Time	Name	Number	Account
2012-12-31	20:31:35		<a href="#">6045550149</a>	1
2012-12-31	20:31:28		<a href="#">6045550123</a>	1
2013-01-08	17:08:45	Ron Benoit	<a href="#">242</a>	1
2013-01-01	21:09:02		<a href="#">2325550192</a>	1

## Servicing Pages

### Reboot

To manually reboot the C520 and apply settings that you have updated, click [Reboot](#).

The screenshot shows the 'SERVICING' menu on the left with 'Reboot' selected. The main content area has a top navigation bar with 'STATUS', 'SYSTEM', 'NETWORK', 'CONTACTS', and 'SERVICING'. Below this, the 'Reboot' section contains a 'Reboot Device:' label and a 'Reboot' button.

### Time and Date

On the Time and Date page, you can manually set the time and date, and the time and date formats. You can also set the system time to follow a Network Time Protocol (NTP) Server (recommended) or you can set the time and date manually.

The time and date settings are also available as parameters in the configuration file. See *“time\_date” Module: Time and Date Settings* on page 116.

The screenshot shows the 'SERVICING' menu on the left with 'Time and Date' selected. The main content area has a top navigation bar with 'STATUS', 'SYSTEM', 'NETWORK', 'CONTACTS', and 'SERVICING'. Below this, the 'Time and Date' section is divided into three sub-sections:
 

- Time and Date Format:** Includes 'Date Format:' (DD/MM/YY) and 'Time Format:' (24 Hour).
- Network Time Settings:** Includes a checked 'Enable Network Time' checkbox, an 'NTP Server:' field (us.pool.ntp.org), and an unchecked 'Use DHCP (Option 42)' checkbox.
- Time Zone and Daylight Savings Settings:** Includes a 'Time Zone:' dropdown (-5 United States-Eastern), a checked 'Automatically adjust clock for Daylight Savings' checkbox, an unchecked 'User-defined Daylight Savings Time' checkbox, and fields for 'Daylight Savings Start:' (March, Week 2, Sunday, 02:00) and 'Daylight Savings End:' (November, Week 1, Sunday, 02:00). It also has a 'Daylight Savings Offset (minutes):' field (60) and an unchecked 'Use DHCP (Option 2/100/101)' checkbox.
- Manual Time Settings:** Includes 'Date:' (15/12/2016) and 'Time:' (19:23:37) fields, an 'Apply Now' button, and a 'Save' button.

## Time and Date Format

Click the link for each setting to see the matching configuration file parameter in *“time\_date” Module: Time and Date Settings* on page 116. Default values and ranges are listed there.

Setting	Description
Date Format	Sets the date format.
Time Format	Sets the clock to a 24-hour or 12-hour format.

## Network Time Settings

Setting	Description
Enable Network Time	Enables or disables getting time and date information for your phone from the Internet.
NTP Server	If Enable Network Time is selected, enter the URL of your preferred time server.
Use DHCP (Option 42)	If Enable Network Time is selected, select to use DHCP to locate the time server. Option 42 specifies the NTP server available to the phone. When enabled, the phone obtains the time in the following priority: <ol style="list-style-type: none"> <li>1. Option 42</li> <li>2. NTP Server</li> <li>3. Manual time.</li> </ol>

## Time Zone and Daylight Savings Settings

Setting	Description
Time Zone	Select your time zone from the list.
Automatically adjust clock for Daylight Savings	Select to adjust the clock for daylight savings time according to the NTP server and time zone setting. To disable daylight savings adjustment, disable both this setting and User-defined Daylight Savings Time.
User-defined DST	Select to set your own start and end dates and offset for Daylight Savings Time. To disable daylight savings adjustment, disable both this setting and Automatically adjust clock for Daylight Savings.
DST Start: Month DST Start: Week DST Start: Day DST Start: Hour	If User-defined DST is enabled, set the start date and time for daylight savings: Month, week, day, and hour.

Setting	Description
DST End: Month DST End: Week DST End: Day DST End: Hour	If User-defined DST is enabled, set the end date and time for daylight savings: Month, week, day, and hour.
Daylight Savings Offset	If User-defined DST is enabled, this specifies the daylight savings adjustment (in minutes) to be applied when the current time is between Daylight Savings Start and Daylight Savings End.
Use DHCP (Option 2/100/101)	If Enable Network Time is selected, select to use DHCP to determine the time zone offset. Options 2, 100 and 101 determine time zone information.

### Manual Time Settings

If Enable Network Time is disabled or if the time server is not available, use Manual Time Settings to set the current time.

Setting	Description
Date	Select the current year, month, and day. Click the <b>Date</b> field and select the date from the calendar that appears.
Time	Sets the current hour, minute, and second. Click the Time field, and enter the current time. You can also refresh the page to update the manual time settings.

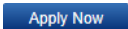
Click  to start the C520 using the manual time settings.

## Firmware Upgrade

You can update the C520 with new firmware using the following methods:

- Retrieving a firmware update file from a remote host computer and accessed via a URL. This central location may be arranged by you, an authorized dealer, or your SIP service provider. Enter the URL under **Firmware Server Settings**.
- Using a file located on your computer or local network. No connection to the Internet is required. Consult your dealer for access to firmware update files. Click **Manual Upgrade** to view the page where you can manually upgrade the C520 firmware.

The firmware upgrade settings are also available as parameters in the configuration file. See *“provisioning” Module: Provisioning Settings* on page 111.

### Firmware Server Settings

Click the link for each setting to see the matching configuration file parameter in *“provisioning” Module: Provisioning Settings* on page 111. Default values and ranges are listed there.

Setting	Description
Firmware URL	The URL where the firmware update file resides. This should be a full path, including the filename of the firmware file.
Server authentication name	Authentication username for the firmware server.
Server authentication password	Authentication password for the firmware server.

**To update the firmware immediately:**

- Click  .



**NOTE**

You can also configure the C520 to check for firmware updates at regular intervals. See *“Provisioning”* on page 74.



## Manual Firmware Update and Upload

On the Manual Firmware Update Settings page, you can upgrade the C520 firmware using a file located on your computer or local network.

### *To update the firmware using a file on your computer or local network:*

1. On the Manual Firmware Update page, click  to locate and open the firmware update file.
2. Click  .

After clicking  the C520 will update its firmware and restart.

## Provisioning

Provisioning refers to the process of acquiring and applying new settings for the C520 using configuration files retrieved from a remote computer. After a C520 is deployed, subsequent provisioning can update the C520 with new settings; for example, if your service provider releases new features. See also “*Provisioning Using Configuration Files*” on page 85.

With automatic provisioning, you enable the C520 to get its settings automatically—the process occurs in the background as part of routine system operation. Automatic provisioning can apply to multiple devices simultaneously.

With manual provisioning on the WebUI, you update the C520 settings (configuration and/or firmware) yourself via **Provisioning > Import Configuration** and/or **Firmware Upgrade > Manual Upgrade**. Manual provisioning can only be performed on one C520 at a time.

On the Provisioning page, you can enter settings that will enable the C520 to receive automatic configuration and firmware updates. The Provisioning page also allows you to manually update C520 configuration from a locally stored configuration file using an Import function. You can also export the C520 configuration—either to back it up or apply the configuration to another C520 in the future—to a file on your computer.

The provisioning process functions according to the Resynchronization settings and Provisioning Server Settings. The C520 checks for the provisioning URL from the following sources in the order listed below:

1. PnP—Plug and Play Subscribe and Notify protocol
2. DHCP Options
3. Preconfigured URL—Any C520 updated to the latest firmware release will have the Redirection Server URL available as the default Provisioning Server URL (see “*provisioning.server\_address*” on page 111).



Using the Redirection Service requires contacting the VTech support team for an account.

If one of these sources is disabled, not available, or has not been configured, the C520 proceeds to the next source until reaching the end of the list.

The provisioning settings are also available as parameters in the configuration file. See “*“provisioning” Module: Provisioning Settings*” on page 111.

**SERVICING**

Reboot

Time and Date

Firmware Upgrade

Auto Upgrade

Manual Upgrade

Provisioning

Security

Certificates

Device Certificate

Server Certificate

System Logs

STATUS
SYSTEM
NETWORK
CONTACTS
SERVICING

### Provisioning Server

Server URL:

Server Authentication Name:

Server Authentication Password:

### Plug-and-Play Settings

Enable PnP Subscribe

### DHCP Settings

Use DHCP Options

DHCP Option Priority 1:

DHCP Option Priority 2:

DHCP Option Priority 3:

Vendor Class ID (DHCP 60):

User Class Info (DHCP 77):

## Provisioning Server

Setting	Description
Server URL	URL of the provisioning file(s). The format of the URL must be RFC 1738 compliant, as follows: "<schema>://<user>:<password>@<host>:<port>/<url-path>" "<user>:<password>@" may be empty. "<port>" can be omitted if you do not need to specify the port number.
Server authentication name	User name for access to the provisioning server
Server authentication password	Password for access to the provisioning server

## Plug-and-Play Settings

Setting	Description
Enable PnP Subscribe	Select to enable the C520 to search for the provisioning URL via a SUBSCRIBE message to a multicast address (224.0.1.75). The C520 expects the server to reply with a NOTIFY that includes the provisioning URL. The process times out after five attempts.

## DHCP Settings

Setting	Description
Use DHCP Options	Enables the C520 to use DHCP options to locate and retrieve the configuration file. When selected, the C520 automatically attempts to get a provisioning server address, and then the configuration file. If DHCP options do not locate a configuration file, then the server provisioning string is checked. <b>Note:</b> Ensure that DHCP is also enabled on the “Basic Network Settings” page.
DHCP Option Priority 1	If DHCP is enabled, sets the DHCP Option priority. Select the highest priority option.
DHCP Option Priority 2	If DHCP is enabled, sets the DHCP Option priority. Select the second highest priority option.
DHCP Option Priority 3	If DHCP is enabled, sets the DHCP Option priority. Select the third highest priority option.
Vendor Class ID (DHCP 60)	DHCP Option 60 is available to send vendor-specific information to the DHCP Server.
User Class Info (DHCP 77)	DHCP Option 77 is available to send vendor-specific information to the DHCP Server.

## Resynchronization

On the Resynchronization page, you can select how and when the phone checks for updated firmware and/or configuration files.

### Resynchronization

Mode:

Bootup Check:

Schedule Check:

Disable

Interval(minutes)

Days of the Week

Monday

Tuesday

Wednesday

Thursday

Friday

Saturday

Sunday

Start Hour:

End Hour:

Use encryption for configuration file

Passphrase:

Setting	Description
Mode	Sets which files for which the C520 checks. It can check for configuration files, firmware update files (from the URL entered on the Firmware Server Settings page), or both. <b>Note:</b> When checking for both configuration and firmware files, the firmware URL can be within the config file. This firmware URL takes precedence over the URL on the Firmware Server Settings page. It will also update the URL on the Firmware Server Settings page. This allows you to change the firmware URL automatically.
Bootup Check	Sets the C520 to check the provisioning URL for new configuration and/or firmware files upon bootup. The update is applied as part of the reboot process.
Schedule Check: Disable	When selected, disables regularly scheduled file checking.
Schedule Check: Interval	Sets an interval for checking for updates. After selecting Interval, enter the interval in minutes between update checks.
Schedule Check: Days of the Week	Select to enable weekly checking for updates on one or more days. After selecting Days of the Week, select the day(s) on which the C520 checks for updates.
Start Hour	Select the hour of the day on which the C520 checks for updates.
End Hour	Select the hour of the day on which the C520 stops checking for updates.
Use encryption	Enables an AES-encrypted configuration file to be decrypted before being applied to the C520. Select if the configuration file has been secured using AES encryption. See <i>“Securing configuration files with AES encryption” on page 91.</i>
Passphrase	If the configuration file has been secured using AES encryption, enter the 16-bit key. See <i>“Securing configuration files with AES encryption” on page 91.</i>

## Import Configuration

You can configure the C520 by importing a configuration file from your computer or your local network. For more information about configuration file types and configuration file formatting, see “*Provisioning Using Configuration Files*” on page 85.

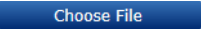
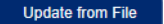

### To import a configuration file:

1. Click  to locate and open the configuration file.
2. Click  .

The C520 will update its configuration.

Manually importing a configuration file differs from the auto-provisioning process in that:

- The C520 does not check whether the file has been loaded before. The configuration file is processed whether or not it is different from the current version.
- The C520 will restart immediately after importing the configuration file, without waiting for one minute of inactivity.

## Export Configuration

You can export all the settings you have configured on the WebUI and save them as a configuration file on your computer. You can then use this configuration file as a backup, or use it to update other phones.

Under **Export Configuration**, you can also reset the phone to its default configuration.



**NOTE**

The exported configuration file will contain the following passwords in plain text:

- SIP account authentication password
- EAPOL password
- Firmware server password
- Provisioning server password
- Encryption passphrase
- LDAP server password
- Broadsoft directory server password.

Please ensure that you save the exported configuration file in a secure location. You can also disable passwords from being exported as plain text. See “*provisioning.pwd\_export\_enable*” on page 115.

**To export the configuration file:**

- Click  .

The format of the exported file is **<model name>\_<mac address>.cfg**. For example, **C520\_0011A0OCF489.cfg**.

Exporting a configuration file generates two header lines in the configuration file. These header lines provide the model number and software version in the following format:

```
#Model Number = xxxxxxxx
```

```
#SW Version = xxxxxxxx
```

You can use the exported file as a general configuration file, and duplicate the settings across multiple units. However, ensure that you edit the file to remove any MAC-specific SIP account settings before applying the general configuration file to other units.

## Reset Configuration

You can reset the phone to its default settings.

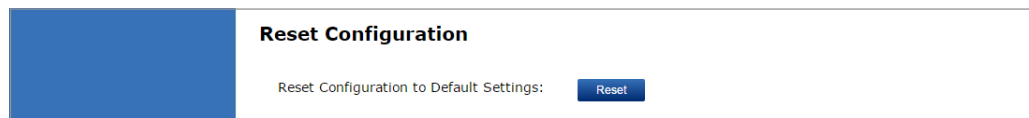

**To reset the C520 to its default configuration:**

1. Under **Reset Configuration**, click  .
2. When the confirmation box appears, click **OK**.

## Security

On the **Security** page you can reset the admin password, reset the user password, and enter web server settings.

The security settings are also available as parameters in the configuration file. See *“web” Module: Web Settings* on page 126.

## Passwords

You can set the administrator password and user password on the WebUI or by using provisioning. For more information on using provisioning to set passwords, see *“profile” Module: Password Settings* on page 141.

The screenshot shows the 'SERVICING' menu on the left with 'Security' selected. The main content area has tabs for STATUS, SYSTEM, NETWORK, CONTACTS, and SERVICING. Under the 'SERVICING' tab, the 'Passwords' section is visible. It contains two sub-sections: 'Administrator Password' and 'User Password'. Each sub-section has three input fields: 'Enter Old Password', 'Enter New Password', and 'Re-enter New Password'. A 'Save' button is located at the bottom of the form.

### To change the admin password:

1. Enter the old password (for a new C520, the default password is **admin**).
2. Enter and re-enter a new password. The password is case sensitive and can consist of both numbers and letters (to a maximum of 15 characters).
3. Click  .

### To change the User password:

1. Enter the old password (for a new C520, the default password is **user**).
2. Enter and re-enter a new password. The password is case sensitive and can consist of both numbers and letters (to a maximum of 15 characters).
3. Click  .



## Web Server

**Web Server**

WARNING: Changing the Web Server settings will reboot your phone.

HTTP Server Port:

Enable Secure Browsing

HTTPS Server Port:

Setting	Description
HTTP Server port	Port used by the HTTP server.
Enable Secure Browsing	Sets the server to use the HTTPS protocol.
HTTPS Server port	Port used by the HTTPS server.

### To configure Web Server Settings:

1. Enter the HTTP Server port number. The default setting is 80.
2. Enable or Disable Secure Browsing. When enabled, the HTTPS protocol is used, and you must select the HTTPS server port in the next step.
3. Enter the HTTPS server port number. The default setting is 443.



Changing the Web Server settings will reboot the C520.

**NOTE**

## Certificates



You can add two types of certificates using the WebUI or the provisioning file (see *“file” Module: Imported File Settings* on page 135). The two types of certificates are:

- Device—A single Device Certificate can be uploaded so that other parties can authenticate the phone in the following cases:
  - When the phone acts as a web server for the user to manage configurations.
  - When the phone acts as a client for applications where HTTP is supported.
- Server—A web server certificate can also be uploaded using provisioning. This certificate (also called a trusted certificate) is for server authentication with secured HTTP transaction in the following applications: SIP signaling, Provisioning, Firmware, LDAP directory service, and Broadsoft directory service.

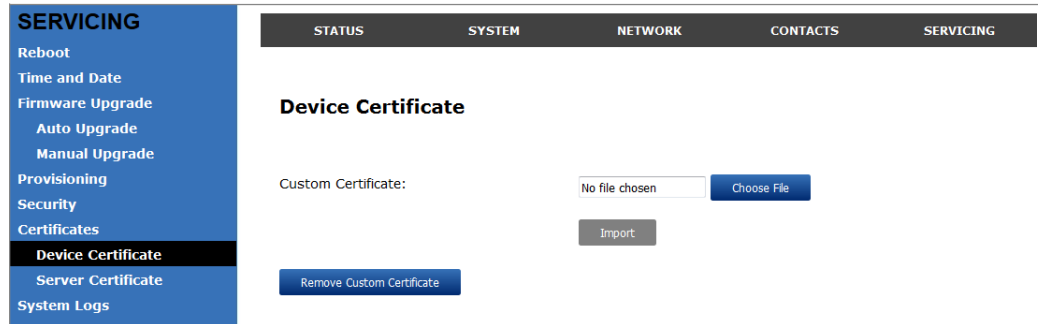
## Device Certificate



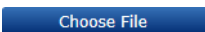

### To upload a Device certificate:

1. On the Device Certificate page, click  .
2. Locate the certificate file and click **Open**.
3. On the Device Certificate page, click  .

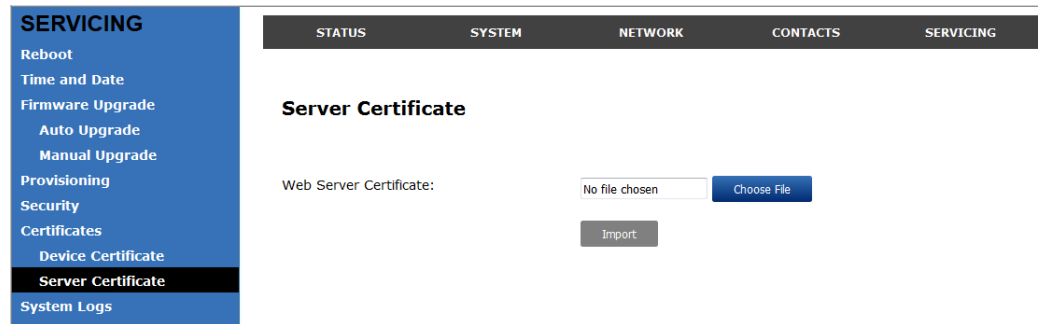
## Server Certificate

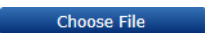

### To upload a web server certificate:

1. On the Server Certificate page, click  .
2. Locate the certificate file and click **Open**.
3. On the Server Certificate page, click  .

## System Logs

On the **Syslog Settings** page, you can enter settings related to system logging activities. It supports the following logging modes:

- Syslog server
- Volatile file

Under **Network Trace**, you can capture network traffic related to the phone's activity and save the capture as a .pcap file. The file can be used for diagnostic and troubleshooting purposes.

Under **Download Log**, you can save the system log to a file.

The Syslog settings are also available as parameters in the configuration file. See *“log” Module: Log Settings* on page 120.

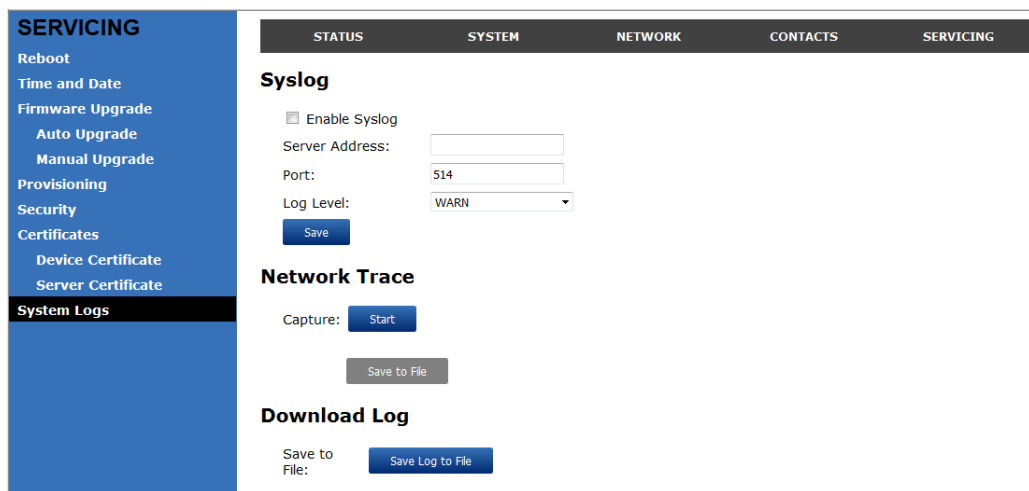

### Syslog Settings





Setting	Description
Enable Syslog	Enable log output to syslog server.
Server address	Syslog server IP address.
Server port	Syslog server port.
Log Level	Sets the log level. The higher the level, the larger the debug output. <ul style="list-style-type: none"> <li>■ 5—ALL</li> <li>■ 4—DEBUG</li> <li>■ 3—INFO</li> <li>■ 2—WARNING</li> <li>■ 1—ERROR</li> <li>■ 0—CRITICAL</li> </ul>

The logging levels are:

- **CRITICAL:** Operating conditions to be reported or corrected immediately (for example, an internal component failure or file system error).
- **ERROR:** Non-urgent failures—unexpected conditions that won't cause the device to malfunction.
- **WARNING:** An indication that an error or critical condition can occur if action is not taken.
- **INFO:** Normal operational messages.
- **DEBUG:** Developer messages for troubleshooting/debugging purposes.

## Network Trace

*To perform a network trace:*

1. Start a network trace by clicking  . The button changes to  .
2. Stop the network trace by clicking  .
3. Save the trace by clicking  . Your browser should prompt you to save the **capture.pcap** file.

## Download Log

*To download the system log:*

1. Click  .
2. After your browser prompts you to save the **system.log** file, save the file in the desired location.

## CHAPTER 4

# PROVISIONING USING CONFIGURATION FILES

Provisioning using configuration files is the quickest way to configure multiple C520 conference phones. You can place configuration files on a provisioning server, where the C520 conference phones retrieve the files and update their configuration automatically.

Configuration files have the extension **.cfg** and contain settings that will apply to C520 conference phones. To edit a configuration file, open it with a text editor such as Notepad.

The settings within a configuration file are grouped into modules. Most of the modules group their settings in the same way that settings are grouped on the C520 WebUI. For example, the "time\_date" module in the configuration file contains the same settings that are on the **Time and Date** WebUI page. For a complete list of C520 configuration file modules and their associated parameters, see *"Configuration File Parameter Guide" on page 93*.

Using the WebUI, you can also import a configuration file and apply the configuration file settings to the C520. For more information, see *"Import Configuration" on page 78*.

This chapter covers:

- *"The Provisioning Process" on page 86*
- *"Configuration File Types" on page 88*
- *"Data Files" on page 89*
- *"Configuration File Tips and Security" on page 90.*

## The Provisioning Process

The automatic provisioning process is as follows:

1. Check for new or updated configuration files. For file-checking options, see “Provisioning” on page 74 and “Resynchronization: configuration file checking” on page 87. The C520 maintains a list of the last loaded provisioning files. The C520 compares its current configuration against the files it finds on the provisioning server. **Checking for update...** appears on the C520 screen.

If provisioning has been triggered by the resync timer expiring or by remote check-sync, the C520 checks for updated files after one minute of inactivity.

2. Download the configuration files.

If any file on the provisioning server has changed, the C520 treats it as a new file and downloads it.

If the provisioning URL specifies a path only with no filename, then by default the C520 looks for and retrieves the following two files:

- General file: **<model>.cfg**.
- MAC-specific file: **<model>\_<MAC Address>.cfg**.

The <model> variable is the VTech product model: **C520-WiMi**, for example.

If the provisioning URL specifies both a path and filename, then the C520 retrieves only the configuration file specified.

3. The C520 restarts after one minute of inactivity.

During provisioning, the C520 reads the configuration file and validates each module and setting. The C520 considers a setting valid if it is:

- a valid data type
- formatted as a valid setting
- within a valid data range
- part of a module that passes an integrity check. That is, the module's settings are consistent and logical. For example, in the "network" module, if DHCP is disabled, but no static IP address is specified, the module will fail the integrity check and none of the settings will apply.

Invalid modules or invalid settings are skipped and logged as ERROR messages in the system log, but will not interrupt the provisioning process. The system log will include the module parameters that have not been applied. A recognized module with unrecognized settings will cause all other settings in that module to be skipped.

A successful configuration or firmware update is reported as an INFO message in the system log.

See “Configuration File Parameter Guide” on page 93 for the options and value ranges available for each configuration file setting.

## Resynchronization: configuration file checking

You can select a number of options that determine when the C520 checks for new configuration files. This process of checking for configuration files is called Resynchronization. Resynchronization options are available on the WebUI **Provisioning** page, but you can also include them in a configuration file.

The resynchronization options are:

- **Mode**—sets the C520 to check for a configuration file only, a firmware update file only, or both types of file.
- **Never**—configuration file checking is disabled
- **Bootup**—the C520 checks for new configuration files when it boots up. Any updates are applied during the boot-up process.
- **Remote check-sync**—enables you to start a resynchronization remotely using your hosted server's web portal. The Remote check-sync settings are available only in the configuration file, not the WebUI.
- **Repeatedly**, at a defined interval from 60 to 65535 minutes (45 days).

## C520 restart

If the C520 needs to restart after an auto-update, the restart happens only after the device has been idle for one minute.

To prevent users from delaying the update process (auto-updates cannot begin until the C520 has been idle for one minute), or to avoid device restarts that might interfere with incoming calls:

- set the resynchronization interval to a suitable period
- upload any new configuration file(s) to your provisioning server after work hours so that the C520 will download the file(s) when there is no call activity.

When you update the C520 by importing a configuration file using the WebUI, the device restarts immediately after applying the new settings, regardless of whether the C520 is idle.

## Configuration File Types

The C520 is able to retrieve and download two types of configuration file. Depending on your requirements, you may want to make both types of configuration file available on your provisioning server.

The two configuration file types are a general configuration file and a MAC-specific configuration file. The types differ in name only. The formatting of the files' content is the same.

The general configuration file contains settings that are required by every C520 in the system.

The MAC-specific configuration file is a file that only a single C520 can retrieve. The MAC-specific configuration file name contains a C520 MAC address and can only be retrieved by the device with a matching MAC address.

The filename formats for both files are:

- General file: **<model>.cfg**
- MAC-specific file: **<model>\_<MAC Address>.cfg**

The <model> variable is the Snom product model; for example, **C520-WiMi**. For more information about the MAC-specific configuration file, see *“Guidelines for the MAC-Specific configuration file” on page 90*.

If the provisioning URL specifies a path only with no filename, then by default the C520 will fetch both files.

However, if the provisioning URL specifies both a path and filename, then the C520 will only fetch the single configuration file specified.

Both the general and MAC-specific files can contain any of the available configuration settings. A setting can appear in the general configuration file or the MAC-specific configuration file, or both files, or neither file. If a setting appears in both files, the setting that is read last is the one that applies.

When the C520 fetches both a general and a MAC-specific configuration file, the general file is processed first. You can configure a setting for most of your C520 conference phones in the general file, and then overwrite that setting for just a few C520 conference phones using the MAC-specific file.



## Data Files

The configuration file can also include links to data files for product customization. Allowed data types include the following:

- Directory (contacts, blacklist) in .xml format
- Certificates (server, provisioning, LDAP, Broadsoft) in pem format
- Logos (a bootup logo and an idle screen logo) in .bmp format

Links to data files are in the configuration file's "file" module. This is where you enter any URLs to the data files that the C520 conference phone may require.

None of the data files are exported when you export a configuration file from the C520. However, you can export a Directory or Blacklist .xml file using the WebUI. After modifying the .xml file, you can use the configuration file "file" module to have the C520 import the new file. For a complete list of data file parameters, see *“file” Module: Imported File Settings* on page 135.

## Configuration File Tips and Security

All configuration settings are initially stored in a configuration template file. Copy, rename, and edit the template file to create a general configuration file and the MAC-specific configuration files you will need. You can store the general configuration file and the MAC-specific files on your provisioning server.

Do not modify the configuration file header line that includes the model and firmware version.

To save yourself time and effort, consider which settings will be common to all (or the majority of) C520 conference phones. Such settings might include call settings, language, and NAT settings. You can then edit those settings in the configuration template and save it as the general configuration file. The remaining settings will make up the MAC-specific configuration file, which you will have to copy and edit for each C520.

### Clearing parameters with %NULL in configuration file

For configuration file parameters that can have a text string value, you can clear the value of the parameter by applying the value %NULL in the configuration file.

For example: `sip_account.1.display_name = %NULL`

However, the following parameters are exceptions. Applying the value %NULL to these parameters will reset them to their default value.

- **file.bootup\_logo** - applying %NULL restores the default value (VTechlogo)
- **file.idle\_logo** - applying %NULL restores the default value (VTechlogo)

### Guidelines for the MAC-Specific configuration file

The C520 downloads the MAC-specific configuration file after the general configuration file. You must create a MAC-specific configuration file for each C520 in your system. The file name must contain the C520 MAC address, which is printed on a label on the of the device, or available on the **MENU > Status > Product Info** screen. For example, a Snom C520 conference phone with the MAC address of 00:11:A0:10:6F:2D would download the **C520-WiMi\_0011A0106F2D.cfg** file.



When renaming a MAC-specific configuration file, ensure the filename is all upper case.

The MAC-specific configuration file contains settings intended exclusively for that C520 conference phone. Such settings will include SIP account settings such as display name, user ID, and authentication ID.

## Securing configuration files with AES encryption

You can encrypt your configuration files to prevent unauthorized users modifying the configuration files. The C520 firmware decrypts files using the AES 256 algorithm. After encrypting a file and placing it on your provisioning server, you can enable the C520 to decrypt the file after fetching it from the server.

The procedures in this section use OpenSSL for Windows for file encryption, as shown in Figure 2.

To decrypt a configuration file, you will need a 16-character AES key that you specified when you encrypted the file. The key (or passphrase) is limited to 16 characters in length and supports special characters ~ ^ ` % ! & - \_ + = | . @ \* : ; , ? ( ) [ ] { } < > / \ # as well as spaces.



The encryption of configuration files is supported only for the auto provisioning process. Encrypt files only if you intend to store them on a provisioning server. Do not encrypt files that you intend to manually import to the C520. You cannot enable decryption for manually imported configuration files.

### To encrypt a configuration file:

1. (Optional) Place your configuration file in the same folder as the openssl executable file. If the configuration file is not in the same folder as the openssl executable file, you can enter a relative pathname for the [infile] in the next step.
2. Double-click the **openssl.exe** file.
3. On the openssl command line, type:

```
enc -aes-256-cbc -pass pass:[passphrase123456] -in [infile] -out [outfile]
-nosalt -p
```

Elements in brackets are examples—do not enter the brackets. Enter a 16-character passphrase and the unencrypted configuration file filename (the "infile") and a name for the encrypted file ("outfile") that will result.

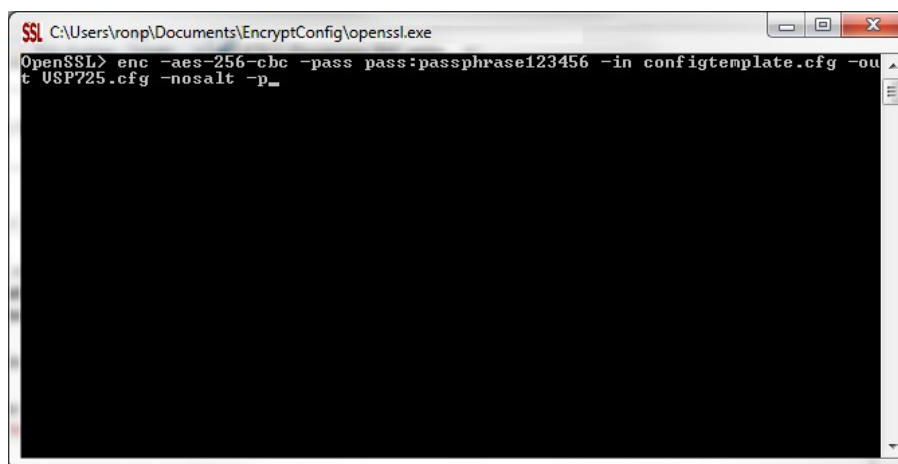

Figure 2. OpenSSL command line

**To enable configuration file decryption:**

1. On the WebUI, click **Servicing > Provisioning**.
2. On the Provisioning page under **Resynchronization**, select **Use Encryption for configuration file**.

**Resynchronization**

Mode:

Bootup Check:

Interval:

Use encryption for configuration file

Passphrase

3. Enter the 16-character passphrase that you created when you encrypted the configuration file.
4. Click  .



NOTE

You must ensure that configuration files are encrypted when enabling AES Encryption. Decrypting an unencrypted file will result in a garbage file that is not processed. This will also be logged as an error in the system log.

---

## CHAPTER 5

# CONFIGURATION FILE PARAMETER GUIDE

This chapter lists the available options for all the settings within the C520 configuration file. Most settings in the configuration file have an equivalent in the WebUI (see the settings tables in “Using the WebUI” on page 30). However, the options you must enter when editing the configuration file have a different syntax and format.

The settings are divided into modules. Most modules correspond to a page on the C520 WebUI. You may wish to reorganize the modules within the configuration file itself. The configuration file settings can be listed in any order, and the configuration file will still be valid.

The device supports the **XML representation of settings** and modules via an XML structure. The settings XML representation is structured into sub tags. Settings are either valid globally for all sip accounts or account-specific, grouped into modules.

One module example is **sip\_account**, which holds the supported per account/identity settings and its values.

### Short form for sip account 1:

```
sip_account.1.sip_account_enable = 1  
sip_account.1.display_name = 1001  
sip_account.1.user_id = 030398331001
```

In this document all settings are in short form representation, which directly translates to XML as demonstrated in the following examples.

### short form:

```
network.ip.dhcp_enable
```

### XML form:

```
<?xml version="1.0"?>
<settings>
  <network>
    <ip>
      <dhcp_enable>1</dhcp_enable>
    </ip>
  </network>
</settings>
```

**short form:**

```
sip_account.1.sip_account_enable = 1
sip_account.1.display_name = 1001
sip_account.1.user_id = 030398331001
```

**XML form with index:**

```
<?xml version="1.0"?>
</settings>
<sip_account>
  <idx id="1">
    <sip_account_enable>1</sip_account_enable>
    <display_name>1001</display_name>
    <user_id>030398331001</user_id>
  </idx>
</sip_account>
</settings>
```

The modules included in the configuration file are:

- *“sip\_account” Module: SIP Account Settings” on page 94*
- *“network” Module: Network Settings” on page 107*
- *“provisioning” Module: Provisioning Settings” on page 111*
- *“time\_date” Module: Time and Date Settings” on page 116*
- *“log” Module: Log Settings” on page 120*
- *“remoteDir” Module: Remote Directory Settings” on page 121*
- *“web” Module: Web Settings” on page 126*
- *“user\_pref” Module: User Preference Settings” on page 127*
- *“call\_settings” Module: Call Settings” on page 131*
- *“speed\_dial” Module: Speed Dial Settings” on page 133*
- *“ringersetting” Module: Distinctive Ringer Settings” on page 134*
- *“file” Module: Imported File Settings” on page 135*

- *“tone” Module: Tone Definition Settings” on page 138*
- *“profile” Module: Password Settings” on page 141*
- *“page\_zone” Module: Paging Zone Settings” on page 142*
- *“softkey” Module: Custom Soft Key Settings” on page 144*
- *“bt\_settings” Module: Bluetooth Settings” on page 146.*

## "sip\_account" Module: SIP Account Settings

The SIP Account settings enable you to set up individual accounts for each user. Each account requires you to configure the same group of SIP account settings. The SIP account settings for each account are identified by the account number, from 1 to 3 for the C520.

For example, for account 1 you would set:

```
sip_account.1.sip_account_enable = 1
sip_account.1.label = Line 1
sip_account.1.display_name = 1001
sip_account.1.user_id = 2325551001
```

and so on. For account 2, you would set:

```
sip_account.2.sip_account_enable = 1
sip_account.2.label = Line 2
sip_account.2.display_name = 1002
sip_account.2.user_id = 2325551002
```

and so on, if you have additional accounts to configure.

The SIP account settings follow the format: sip\_account.x.[element], where x is an account number ranging from 1 to 3 for the C520.

All these settings are exported when you manually export the configuration from the C520.

### General configuration file settings

---

<b>Setting:</b>	<code>sip_account.x.dial_plan</code>		
<b>Description:</b>	Sets the dial plan for account x. See <i>“Dial Plan” on page 36.</i>		
<b>Values:</b>	Text string	<b>Default:</b>	x+P

---

<b>Setting:</b>	<code>sip_account.x.inter_digit_timeout</code>		
<b>Description:</b>	Sets the inter-digit timeout (in seconds) for account x. The inter-digit timeout sets how long the C520 waits after the last digit is entered before dialing the number.		
<b>Values:</b>	1–10	<b>Default:</b>	3
<b>Setting:</b>	<code>sip_account.x.maximum_call_number</code>		
<b>Description:</b>	Sets the maximum number of concurrent active calls allowed for that account.		
<b>Values:</b>	1–6	<b>Default:</b>	6
<b>Setting:</b>	<code>sip_account.x.auto_answer_enable</code>		
<b>Description:</b>	<p>Enables or disables automatic answering of pages for account x.</p> <p>If enabled, incoming calls with a paging tag (as described below) will be automatically picked up using the default audio mode (Speakerphone or Headset).</p> <p>A server-based incoming page is effectively an incoming SIP call that has been tagged to let the phone know that it is an incoming page. ErisTerminal business SIP phones recognize three different tag types:</p> <ol style="list-style-type: none"> <li>An “answer-after” parameter in the “Call-Info” header, as shown in the example below: Call-Info: &lt;sip:broadworks.net&gt;; answer-after=1</li> <li>The “Intercom” parameter in the INVITE, as shown in the example below: INVITE sip:501@192.168.1.108;intercom=true SIP/2.0</li> <li>The “autoanswer” parameter in the “Alert-Info” header, as shown in the example below: &lt;http://www.notused.com&gt;;info=alert-autoanswer;delay=0</li> </ol>		
<b>Values:</b>	0 (disabled), 1 (enabled)	<b>Default:</b>	0
<b>Setting:</b>	<code>sip_account.x.auto_answer_during_active_call</code>		
<b>Description:</b>	Enables or disables automatic answering of pages for account x when account x has an active call.		
<b>Values:</b>	0 (disabled), 1 (enabled)	<b>Default:</b>	0



<b>Setting:</b>	<code>sip_account.x.dtmf_transport_method</code>		
<b>Description:</b>	Sets the transport method for DTMF signalling for account x.		
<b>Values:</b>	auto, rfc2833, inband, info	<b>Default:</b>	auto
<b>Setting:</b>	<code>sip_account.x.unregister_after_reboot_enable</code>		
<b>Description:</b>	Enables or disables the C520 to unregister account x after rebooting.		
<b>Values:</b>	0 (disabled), 1 (enabled)	<b>Default:</b>	0
<b>Setting:</b>	<code>sip_account.x.primary_sip_server_address</code>		
<b>Description:</b>	Sets the SIP server IP address for account x.		
<b>Values:</b>	Text string	<b>Default:</b>	Blank
<b>Setting:</b>	<code>sip_account.x.primary_sip_server_port</code>		
<b>Description:</b>	Sets the SIP server port for account x.		
<b>Values:</b>	1–65535	<b>Default:</b>	5060
<b>Setting:</b>	<code>sip_account.x.primary_registration_server_address</code>		
<b>Description:</b>	Sets the registration server IP address for account x.		
<b>Values:</b>	Text string	<b>Default:</b>	Blank
<b>Setting:</b>	<code>sip_account.x.primary_registration_server_port</code>		
<b>Description:</b>	Sets the registration server port for account x.		
<b>Values:</b>	1–65535	<b>Default:</b>	5060
<b>Setting:</b>	<code>sip_account.x.primary_registration_expires</code>		
<b>Description:</b>	Sets the expiration time (in seconds) of the current registration for account x.		
<b>Values:</b>	30–7200	<b>Default:</b>	3600
<b>Setting:</b>	<code>sip_account.x.registration_retry_time</code>		
<b>Description:</b>	Sets the retry frequency of the current registration for account x.		
<b>Values:</b>	1–1800	<b>Default:</b>	10

---

**Setting:** `sip_account.x.primary_outbound_proxy_server_address`

**Description:** Sets the outbound proxy server IP address for account x.

**Values:** Text string                      **Default:** Blank

---

**Setting:** `sip_account.x.primary_outbound_proxy_server_port`

**Description:** Sets the outbound proxy server port for account x.

**Values:** 1-65535                      **Default:** 5060

---

**Setting:** `sip_account.x.backup_outbound_proxy_server_address`

**Description:** Sets the backup outbound proxy server IP address for accountx.

**Values:** Text string                      **Default:** Blank

---

**Setting:** `sip_account.x.backup_outbound_proxy_server_port`

**Description:** Sets the backup outbound proxy server port for accountx.

**Values:** 1-65535                      **Default:** 5060

---

**Setting:** `sip_account.x.codec_priority.1`

**Description:** Sets the highest-priority codec for account x.

**Values:** g711u, g711a, g729, g726, **Default:** g711u  
g722

---

**Setting:** `sip_account.x.codec_priority.2`

**Description:** Sets the second highest-priority codec for account x.

**Values:** none, g711u, g711a, g729, **Default:** g711a  
g726, g722

---

**Setting:** `sip_account.x.codec_priority.3`

**Description:** Sets the third highest-priority codec for account x.

**Values:** none, g711u, g711a, g729, **Default:** g729  
g726, g722

---

<b>Setting:</b>	<code>sip_account.x.codec_priority.4</code>		
<b>Description:</b>	Sets the fourth highest-priority codec for account x.		
<b>Values:</b>	none, g711u, g711a, g729, g726, g722	<b>Default:</b>	g726
<b>Setting:</b>	<code>sip_account.x.codec_priority.5</code>		
<b>Description:</b>	Sets the fifth highest-priority codec for account x.		
<b>Values:</b>	none, g711u, g711a, g729, g726, g722	<b>Default:</b>	g722
<b>Setting:</b>	<code>sip_account.x.voice_encryption_enable</code>		
<b>Description:</b>	Enables or disables SRTP voice encryption for account x.		
<b>Values:</b>	0 (disabled), 1 (enabled)	<b>Default:</b>	0
<b>Setting:</b>	<code>sip_account.x.g729_annexb_enable</code>		
<b>Description:</b>	Enables G.729 Annex B, with voice activity detection (VAD) and bandwidth-conserving silence suppression. This setting applies only when G.729a/b is selected in a <code>sip_account.x.codec_priority</code> parameter.		
<b>Values:</b>	0 (disabled), 1 (enabled)	<b>Default:</b>	0
<b>Setting:</b>	<code>sip_account.x.dscp</code>		
<b>Description:</b>	Sets the Voice Quality of Service Layer 3 - DSCP for account x.		
<b>Values:</b>	0–63	<b>Default:</b>	46
<b>Setting:</b>	<code>sip_account.x.sip_dscp</code>		
<b>Description:</b>	Sets the Signalling Quality of Service Layer 3 - DSCP for account x.		
<b>Values:</b>	0–63	<b>Default:</b>	26
<b>Setting:</b>	<code>sip_account.x.normal_jitter</code>		
<b>Description:</b>	Sets the oRTP jitter buffer in milliseconds.		
<b>Values:</b>	30–500	<b>Default:</b>	80

<b>Setting:</b>	<code>sip_account.x.local_sip_port</code>		
<b>Description:</b>	Sets the Local SIP port for account x.		
<b>Values:</b>	1-65535	<b>Default:</b>	Account 1: 5060 Account 2: 5070 Account 3: 5080
<b>Setting:</b>	<code>sip_account.x.transport_mode</code>		
<b>Description:</b>	Sets the Signalling Transport Mode for account x.		
<b>Values:</b>	udp, tcp, tls	<b>Default:</b>	udp
<b>Setting:</b>	<code>sip_account.x.access_code_page</code>		
<b>Description:</b>	Sets the paging feature access code for account x.		
<b>Values:</b>	Text string	<b>Default:</b>	Blank
<b>Setting:</b>	<code>sip_account.x.access_code_park_call</code>		
<b>Description:</b>	Sets the Call Park feature access code for account x.		
<b>Values:</b>	Text string	<b>Default:</b>	Blank
<b>Setting:</b>	<code>sip_account.x.access_code_retrieve_parked_call</code>		
<b>Description:</b>	Sets the retrieve parked call feature access code for account x.		
<b>Values:</b>	Text string	<b>Default:</b>	Blank
<b>Setting:</b>	<code>sip_account.x.access_code_retrieve_voicemail</code>		
<b>Description:</b>	Sets the voicemail retrieval feature access code for account x.		
<b>Values:</b>	Text string	<b>Default:</b>	Blank
<b>Setting:</b>	<code>sip_account.x.access_code_dnd_on</code>		
<b>Description:</b>	Sets the do not disturb (DND) ON feature access code for account x.		
<b>Values:</b>	Text string	<b>Default:</b>	Blank

<b>Setting:</b>	<code>sip_account.x.access_code_dnd_off</code>		
<b>Description:</b>	Sets the do not disturb (DND) OFF feature access code for account x.		
<b>Values:</b>	Text string	<b>Default:</b>	Blank
<b>Setting:</b>	<code>sip_account.x.access_code_cfa_on</code>		
<b>Description:</b>	Sets the Call Forward All ON feature access code for account x.		
<b>Values:</b>	Text string	<b>Default:</b>	Blank
<b>Setting:</b>	<code>sip_account.x.access_code_cfa_off</code>		
<b>Description:</b>	Sets the Call Forward All OFF feature access code for account x.		
<b>Values:</b>	Text string	<b>Default:</b>	Blank
<b>Setting:</b>	<code>sip_account.x.access_code_cfna_on</code>		
<b>Description:</b>	Sets the Call Forward No Answer ON feature access code for account x.		
<b>Values:</b>	Text string	<b>Default:</b>	Blank
<b>Setting:</b>	<code>sip_account.x.access_code_cfna_off</code>		
<b>Description:</b>	Sets the Call Forward No Answer OFF feature access code for account x.		
<b>Values:</b>	Text string	<b>Default:</b>	Blank
<b>Setting:</b>	<code>sip_account.x.access_code_cfb_on</code>		
<b>Description:</b>	Sets the Call Forward Busy ON feature access code for account x.		
<b>Values:</b>	Text string	<b>Default:</b>	Blank
<b>Setting:</b>	<code>sip_account.x.access_code_cfb_off</code>		
<b>Description:</b>	Sets the Call Forward Busy OFF feature access code for account x.		
<b>Values:</b>	Text string	<b>Default:</b>	Blank
<b>Setting:</b>	<code>sip_account.x.access_code_anonymous_call_block_on</code>		
<b>Description:</b>	Sets the Anonymous Call Block ON feature access code for account x.		
<b>Values:</b>	Text string	<b>Default:</b>	Blank

<b>Setting:</b>	<code>sip_account.x.access_code_anonymous_call_block_off</code>		
<b>Description:</b>	Sets the Anonymous Call Block OFF feature access code for account x.		
<b>Values:</b>	Text string	<b>Default:</b>	Blank
<b>Setting:</b>	<code>sip_account.x.access_code_outgoing_call_anonymous_on</code>		
<b>Description:</b>	Sets the Anonymous Outgoing Call ON feature access code for account x.		
<b>Values:</b>	Text string	<b>Default:</b>	Blank
<b>Setting:</b>	<code>sip_account.x.access_code_outgoing_call_anonymous_off</code>		
<b>Description:</b>	Sets the Anonymous Outgoing Call OFF feature access code for account x.		
<b>Values:</b>	Text string	<b>Default:</b>	Blank
<b>Setting:</b>	<code>sip_account.x.access_code_call_waiting_on</code>		
<b>Description:</b>	Sets the Call Waiting ON feature access code for account x.		
<b>Values:</b>	Text string	<b>Default:</b>	Blank
<b>Setting:</b>	<code>sip_account.x.access_code_call_waiting_off</code>		
<b>Description:</b>	Sets the Call Waiting OFF feature access code for account x.		
<b>Values:</b>	Text string	<b>Default:</b>	Blank
<b>Setting:</b>	<code>sip_account.x.access_code_group_call_pickup</code>		
<b>Description:</b>	Sets the Group Call Pickup feature access code for account x.		
<b>Values:</b>	Text string	<b>Default:</b>	Blank
<b>Setting:</b>	<code>sip_account.x.access_code_direct_call_pickup</code>		
<b>Description:</b>	Sets the Direct Call Pickup feature access code for account x.		
<b>Values:</b>	Text string	<b>Default:</b>	Blank
<b>Setting:</b>	<code>sip_account.x.mwi_enable</code>		
<b>Description:</b>	Enables or disables message waiting indicator subscription for account x. Enable if SUBSCRIBE and NOTIFY methods are used for MWI.		
<b>Values:</b>	0 (disabled), 1 (enabled)	<b>Default:</b>	0

---

<b>Setting:</b>	<code>sip_account.x.mwi_subscription_expires</code>		
<b>Description:</b>	Sets the MWI subscription expiry time (in seconds) for account x.		
<b>Values:</b>	0–65535	<b>Default:</b>	3600

---

<b>Setting:</b>	<code>sip_account.x.mwi_ignore_unsolicited</code>		
<b>Description:</b>	Enables or disables ignoring of unsolicited MWI notifications—notifications in addition to, or instead of, SUBSCRIBE and NOTIFY methods—for account x. Disable if MWI service is configured on the voicemail server and does not involve a subscription to a voicemail server.		
<b>Values:</b>	0 (disabled), 1 (enabled)	<b>Default:</b>	

---

<b>Setting:</b>	<code>sip_account.x.stutter_dial_tone_enable</code>		
<b>Description:</b>	Enables or disables MWI stutter dial tone for account x.		
<b>Values:</b>	0 (disabled), 1 (enabled)	<b>Default:</b>	1

---

<b>Setting:</b>	<code>sip_account.x.nat_traversal_stun_enable</code>		
<b>Description:</b>	Enables or disables STUN (Simple Traversal of UDP through NATs) for account x. STUN enables clients, each behind a firewall, to establish calls via a service provider hosted outside of either local network.		
<b>Values:</b>	0 (disabled), 1 (enabled)	<b>Default:</b>	0

---

<b>Setting:</b>	<code>sip_account.x.nat_traversal_stun_server_address</code>		
<b>Description:</b>	Sets the STUN server IP address.		
<b>Values:</b>	Text string	<b>Default:</b>	Blank

---

<b>Setting:</b>	<code>sip_account.x.nat_traversal_stun_server_port</code>		
<b>Description:</b>	Sets the STUN server port.		
<b>Values:</b>	1–65535	<b>Default:</b>	3478

---

<b>Setting:</b>	<code>sip_account.x.nat_traversal_udp_keep_alive_enable</code>		
<b>Description:</b>	Enables or disables UDP keep-alives. Keep-alive packets are used to maintain connections established through NAT.		
<b>Values:</b>	0 (disabled), 1 (enabled)	<b>Default:</b>	1

---

---

<b>Setting:</b>	<code>sip_account.x.nat_traversal_udp_keep_alive_interval</code>		
<b>Description:</b>	Sets the interval (in seconds) for sending UDP keep-alives.		
<b>Values:</b>	0–65535	<b>Default:</b>	30

---

<b>Setting:</b>	<code>sip_account.x.music_on_hold_enable</code>		
<b>Description:</b>	Enables or disables a hold-reminder tone that a far-end caller hears when put on hold during a call on account x.		
<b>Values:</b>	0 (disabled), 1 (enabled)	<b>Default:</b>	1

---

<b>Setting:</b>	<code>sip_account.x.network_conference_enable</code>		
<b>Description:</b>	Enables or disables network conferencing for account x.		
<b>Values:</b>	0 (disabled), 1 (enabled)	<b>Default:</b>	0

---

<b>Setting:</b>	<code>sip_account.x.network_bridge_uri</code>		
<b>Description:</b>	Sets the URI for the network conferencing bridge on account x.		
<b>Values:</b>	Text string (SIP URI)	<b>Default:</b>	Blank

---

<b>Setting:</b>	<code>sip_account.x.sip_session_timer_enable</code>		
<b>Description:</b>	Enables or disables the SIP session timer.		
<b>Values:</b>	0 (disabled), 1 (enabled)	<b>Default:</b>	0

---

<b>Setting:</b>	<code>sip_account.x.sip_session_timer_min</code>		
<b>Description:</b>	Sets the session timer minimum value (in seconds) for account x.		
<b>Values:</b>	90–65535	<b>Default:</b>	90

---

<b>Setting:</b>	<code>sip_account.x.sip_session_timer_max</code>		
<b>Description:</b>	Sets the session timer maximum value (in seconds) for account x.		
<b>Values:</b>	0–65535	<b>Default:</b>	1800

---

<b>Setting:</b>	<code>sip_account.x.check_trusted_certificate</code>		
<b>Description:</b>	Enables or disables accepting only a trusted TLS certificate for account x.		
<b>Values:</b>	0 (disabled), 1 (enabled)	<b>Default:</b>	0

---



---

**Setting:** `sip_account.use_first_trusted_certificate_for_all`  
**Description:** Enables or disables accepting the first TLS certificate for all accounts.  
**Values:** 0 (disabled), 1 (enabled)     **Default:** 0

---

**Setting:** `sip_account.x.park_variant`  
**Description:** Selects how the C520 handles call parking, depending on the service provider. When the default "broadsoft" variant is selected, calls are parked via a PFK and a feature access code. The target number for the "park" request is formed by concatenating "Call Park FAC" of the call-to-be-parked account and the value entered for the Park PFK. When the "asterisk" variant is selected, calls are parked through a blind transfer to a parking lot extension. The target parking lot extension will be taken from the following order of priority (if both values exist):

- Park PFK Value
- Call Park FAC Value

**Values:** broadsoft, asterisk     **Default:** broadsoft

---

**Setting:** `sip_account.x.preferred_ptime`  
**Description:** Enter the packetization interval time in milliseconds.  
**Values:** 10, 20, 30, 40, 50, 60     **Default:** 20

---

**Setting:** `sip_account.x.call_rejection_response_code`  
**Description:** Select the response code for call rejection. This code applies to the following call rejection cases:

- User presses **Reject** for an incoming call
- DND is enabled
- Phone rejects a second incoming call with Call Waiting disabled
- Phone rejects an anonymous call with Anonymous Call Rejection enabled
- Phone rejects call when the maximum number of calls is reached

**Values:** 480, 486, 603     **Default:** 486

---

---

## MAC-specific configuration file settings

---

**Setting:** `sip_account.x.sip_account_enable`  
**Description:** Enables account x to be used by the device.  
**Values:** 0 (disabled), 1 (enabled)    **Default:** 0

---

**Setting:** `sip_account.x.label`  
**Description:** Sets the text that identifies the account on the device LCD. The account label appears on the idle screen, dialing screen, and other call appearance screens.  
**Values:** Text string    **Default:** Blank

---

**Setting:** `sip_account.x.display_name`  
**Description:** Sets the text portion of the caller ID that is displayed for outgoing calls using account x.  
**Values:** Text string    **Default:** Blank

---

**Setting:** `sip_account.x.user_id`  
**Description:** Sets the account ID for account x. Depending on your service provider's specifications, this could be an extension number.  
**Note:** Do not enter the host name (e.g. "@sipservice.com"). The configuration file automatically adds the default host name.  
**Values:** Text string    **Default:** Blank

---

**Setting:** `sip_account.x.authentication_name`  
**Description:** Sets the authentication name for account x. Depending on your service provider's specifications, this could be identical to the user ID.  
**Values:** Text string    **Default:** Blank

---

**Setting:** `sip_account.x.authentication_access_password`  
**Description:** Sets the authentication password for account x.  
**Values:** Text string    **Default:** Blank

---

---

**Setting:** `sip_account.x.feature_sync_enable`

**Description:** Enables or disables feature synchronization for account x. When enabled, features configured on the service provider's web portal will automatically be updated on the device's WebUI.

**Values:** 0 (disabled), 1 (enabled)      **Default:** 0

---

**Setting:** `sip_account.x.mwi_uri`

**Description:** Sets the MWI URI that will be used for MWI subscription. If this setting is left blank, the C520 uses the account x user ID for MWI subscription.

**Values:** SIP URI text string      **Default:** Blank

---

## "network" Module: Network Settings

The network settings follow the format: network.[element].

### General configuration file settings

---

<b>Setting:</b>	<code>network.rtp.port_start</code>		
<b>Description:</b>	Sets the Local RTP port range start.		
<b>Values:</b>	1–65535	<b>Default:</b>	18000

---

<b>Setting:</b>	<code>network.rtp.port_end</code>		
<b>Description:</b>	Sets the Local RTP port range end.		
<b>Values:</b>	1–65535	<b>Default:</b>	19000

---

<b>Setting:</b>	<code>network.vlan.wan.enable</code>		
<b>Description:</b>	Enables or disables the WAN VLAN.		
<b>Values:</b>	0 (disabled), 1 (enabled)	<b>Default:</b>	0

---

<b>Setting:</b>	<code>network.vlan.wan.id</code>		
<b>Description:</b>	Sets the WAN VLAN ID.		
<b>Values:</b>	0–4095	<b>Default:</b>	0

---

<b>Setting:</b>	<code>network.vlan.wan.priority</code>		
<b>Description:</b>	Sets the WAN port priority.		
<b>Values:</b>	0–7	<b>Default:</b>	0

---

<b>Setting:</b>	<code>network.lldp_med.enable</code>		
<b>Description:</b>	Enables or disables LLDP-MED.		
<b>Values:</b>	0 (disabled), 1 (enabled)	<b>Default:</b>	1

---

<b>Setting:</b>	<code>network.lldp_med.interval</code>		
<b>Description:</b>	Sets the LLDP-MED packet interval (in seconds).		
<b>Values:</b>	1–30	<b>Default:</b>	10

---

<b>Setting:</b>	<code>network.eapol.enable</code>		
<b>Description:</b>	Enables or disables 802.1x EAPOL.		
<b>Values:</b>	0 (disabled), 1 (enabled)	<b>Default:</b>	0
<b>Setting:</b>	<code>network.eapol.identity</code>		
<b>Description:</b>	Sets the 802.1x EAPOL identity.		
<b>Values:</b>	Text string	<b>Default:</b>	Blank
<b>Setting:</b>	<code>network.eapol.access_password</code>		
<b>Description:</b>	Sets the 802.1x EAPOL MD5 password.		
<b>Values:</b>	Text string	<b>Default:</b>	Blank
<b>Setting:</b>	<code>network.vendor_class_id</code>		
<b>Description:</b>	Sets the vendor ID for DHCP option 60.		
<b>Values:</b>	Text string	<b>Default:</b>	snomC520
<b>Setting:</b>	<code>network.user_class</code>		
<b>Description:</b>	Sets the user class for DHCP option 77.		
<b>Values:</b>	Text string	<b>Default:</b>	snomC520
<b>Setting:</b>	<code>network.ip_dns_cache_clear_timeout</code>		
<b>Description:</b>	Sets the interval (in minutes) between removing all caching and performing a new DNS lookup. Set to 0 to remove all caching and perform a DNS lookup for every outgoing request and response (TTL=0 emulation).		
<b>Values:</b>	0–1440	<b>Default:</b>	60

---

## MAC-specific configuration file settings

---

**Setting:** `network.nat.masquerading_enable`

**Description:** Enables or disables IP masquerading.

**Values:** 0 (disabled), 1 (enabled)    **Default:** 0

---

**Setting:** `network.nat.public_ip_addr`

**Description:** Sets the public IP address.

**Values:** Text string (IPv4)    **Default:** 0

---

**Setting:** `network.nat.public_sip_port`

**Description:** Sets the public SIP port.

**Values:** 1–65535    **Default:** 5060

---

**Setting:** `network.nat.public_rtp_port_start`

**Description:** Sets the public RTP port range start.

**Values:** 1–65535    **Default:** 18000

---

**Setting:** `network.nat.public_rtp_port_end`

**Description:** Sets the public RTP port range end.

**Values:** 1–65535    **Default:** 19000

---

**Setting:** `network.ip.dhcp_enable`

**Description:** Indicates whether DHCP is enabled.

**Values:** 0 (disabled), 1 (enabled)    **Default:** 1

---

**Setting:** `network.ip.static_ip_addr`

**Description:** Sets a static IP address for the network.

**Values:** Text string (IPv4)    **Default:** Blank

---

---

**Setting:** `network.ip.subnet_mask`  
**Description:** Sets the subnet mask for the network.  
**Values:** Text string (IPv4)      **Default:** Blank

---

**Setting:** `network.ip.gateway_addr`  
**Description:** Sets the Gateway IP address.  
**Values:** Text string (IPv4)      **Default:** Blank

---

**Setting:** `network.ip.dns1`  
**Description:** Sets the primary DNS server IP address.  
**Values:** Text string (IPv4)      **Default:** Blank

---

**Setting:** `network.ip.dns2`  
**Description:** Sets the secondary DNS server IP address.  
**Values:** Text string (IPv4)      **Default:** Blank

---

## "provisioning" Module: Provisioning Settings

The provisioning settings follow the format: provisioning.[element].

All these settings are exported when you manually export the configuration from the C520.

All the provisioning settings are included in the general configuration file.

---

<b>Setting:</b>	<code>provisioning.click_to_dial</code>
<b>Description:</b>	Enables or disables "click to dial" functionality for directory entries.
<b>Values:</b>	0 (disabled), 1 (enabled) <b>Default:</b> 1

---

<b>Setting:</b>	<code>provisioning.firmware_url</code>
<b>Description:</b>	Sets the URL for the server hosting the firmware file.
<b>Values:</b>	Text string <b>Default:</b> Blank

---

<b>Setting:</b>	<code>provisioning.fw_server_username</code>
<b>Description:</b>	Sets the authentication name for the server hosting the firmware file.
<b>Values:</b>	Text string <b>Default:</b> Blank

---

<b>Setting:</b>	<code>provisioning.fw_server_access_password</code>
<b>Description:</b>	Sets the authentication password for the server hosting the firmware file.
<b>Values:</b>	Text string <b>Default:</b> Blank

---

<b>Setting:</b>	<code>provisioning.server_address</code>
<b>Description:</b>	Sets the provisioning server IP address.
<b>Values:</b>	Text string <b>Default:</b> <code>http://et.vtechphones.com/redirectserver</code>

---

<b>Setting:</b>	<code>provisioning.server_username</code>
<b>Description:</b>	Sets the authentication name for the provisioning server.
<b>Values:</b>	Text string <b>Default:</b> Blank

---



<b>Setting:</b>	<code>provisioning.server_access_password</code>		
<b>Description:</b>	Sets the authentication password for the provisioning server.		
<b>Values:</b>	Text string	<b>Default:</b>	Blank
<b>Setting:</b>	<code>provisioning.dhcp_option_enable</code>		
<b>Description:</b>	Enables or disables using DHCP options for locating the configuration and firmware files.		
<b>Values:</b>	0 (disabled), 1 (enabled)	<b>Default:</b>	1
<b>Setting:</b>	<code>provisioning.dhcp_option_priority_1</code>		
<b>Description:</b>	Sets the first priority DHCP option for the provisioning/firmware file check.		
<b>Values:</b>	66, 159, 160	<b>Default:</b>	66
<b>Setting:</b>	<code>provisioning.dhcp_option_priority_2</code>		
<b>Description:</b>	Sets the second priority DHCP option for the provisioning/firmware file check.		
<b>Values:</b>	66, 159, 160	<b>Default:</b>	159
<b>Setting:</b>	<code>provisioning.dhcp_option_priority_3</code>		
<b>Description:</b>	Sets the third priority DHCP option for the provisioning/firmware file check.		
<b>Values:</b>	66, 159, 160	<b>Default:</b>	160
<b>Setting:</b>	<code>provisioning.resync_mode</code>		
<b>Description:</b>	Sets the mode of the device's provisioning/firmware file check. This determines which files the device retrieves when the resync process begins.		
<b>Values:</b>	config_only, firmware_only, config_and_firmware	<b>Default:</b>	config_and_firmware
<b>Setting:</b>	<code>provisioning.bootup_check_enable</code>		
<b>Description:</b>	Enables or disables bootup check for configuration and firmware files.		
<b>Values:</b>	0 (disabled), 1 (enabled)	<b>Default:</b>	1

<b>Setting:</b>	<code>provisioning.schedule_mode</code>		
<b>Description:</b>	Sets the type of schedule check for configuration and firmware files.		
<b>Values:</b>	disable, interval, weekday	<b>Default:</b>	disable
<b>Setting:</b>	<code>provisioning.resync_time</code>		
<b>Description:</b>	Sets the interval (in minutes) between checks for new firmware and/or configuration files.		
<b>Values:</b>	0–65535	<b>Default:</b>	0 (OFF)
<b>Setting:</b>	<code>provisioning.weekdays</code>		
<b>Description:</b>	Sets the day(s) when the device checks for new firmware and/or configuration files. Enter a comma-delimited list of weekdays from 0 (Sunday) to 6 (Saturday). For example, 5,6,0 means the provisioning check will be performed on Friday, Saturday and Sunday.		
<b>Values:</b>	0–6	<b>Default:</b>	Blank
<b>Setting:</b>	<code>provisioning.weekdays_start_hr</code>		
<b>Description:</b>	Sets the hour when the device checks for new firmware and/or configuration files.		
<b>Values:</b>	0–23	<b>Default:</b>	0
<b>Setting:</b>	<code>provisioning.weekdays_end_hr</code>		
<b>Description:</b>	Sets the hour when the device stops checking for new firmware and/or configuration files.		
<b>Values:</b>	0–23	<b>Default:</b>	0
<b>Setting:</b>	<code>provisioning.remote_check_sync_enable</code>		
<b>Description:</b>	Enables or disables remotely triggering the device to check for new firmware and/or configuration files. The file checking is triggered remotely via a SIP Notify message from the server containing the <b>check-sync</b> event.		
<b>Values:</b>	0 (disabled), 1 (enabled)	<b>Default:</b>	1

---

**Setting:** `provisioning.crypto_enable`

**Description:** Enables or disables encryption check for the configuration file(s). Enable if you have encrypted the configuration file(s) using AES encryption.

**Values:** 0 (disabled), 1 (enabled)      **Default:** 0

---

**Setting:** `provisioning.crypto_passphrase`

**Description:** Sets the AES encryption passphrase for decrypting the configuration file(s). Enter the key that was generated when you encrypted the file.

**Values:** Text string      **Default:** Blank

---

**Setting:** `provisioning.check_trusted_certificate`

**Description:** Enables or disables accepting only a trusted TLS certificate for access to the provisioning server.

**Values:** 0 (disabled), 1 (enabled)      **Default:** 0

---

**Setting:** `provisioning.pnp_enable`

**Description:** Enables or disables the C520 checking for the provisioning URL using the Plug-and-Play Subscribe and Notify protocol.

**Values:** 0 (disabled), 1 (enabled)      **Default:** 1

---

**Setting:** `provisioning.pnp_response_timeout`

**Description:** Sets how long the C520 repeats the SUBSCRIBE request if there is no reply from the PnP server.

**Values:** 1–60      **Default:** 10

---

---

<b>Setting:</b>	<code>provisioning.pwd_export_enable</code>
<b>Description:</b>	Enables or disables passwords from being exported in plain text. This parameter is not available on the WebUI. The passwords affected are: <ul style="list-style-type: none"><li>■ <code>network.eapol.access_password</code></li><li>■ <code>provisioning.fw_server_access_password</code></li><li>■ <code>provisioning.server_access_password</code></li><li>■ <code>profile.admin.access_password</code></li><li>■ <code>profile.user.access_password</code></li><li>■ <code>sip_account.x.authentication_access_password</code></li><li>■ <code>remoteDir.ldap_access_password</code></li><li>■ <code>remoteDir.broadsoft_access_password</code></li></ul>
<b>Values:</b>	0 (disabled), 1 (enabled) <b>Default:</b> 0

---

## "time\_date" Module: Time and Date Settings

The time and date settings follow the format: time\_date.[element].

All these settings are exported when you manually export the configuration from the C520.

All the time and date settings are included in the general configuration file.

---

**Setting:**        time\_date.date\_format

**Description:** Sets the format for displaying the date.

**Values:**        DD/MM/YY, MM/DD/YY,   **Default:**        DD/MM/YY  
                  YY/MM/DD

---

**Setting:**        time\_date.24hr\_clock

**Description:** Enables or disables 24-hour clock.

**Values:**        0 (disabled), 1 (enabled)   **Default:**        1

---

**Setting:**        time\_date.ntp\_server

**Description:** Enables or disables NTP server to set time and date.

**Values:**        0 (disabled), 1 (enabled)   **Default:**        1

---

**Setting:**        time\_date.ntp\_server\_addr

**Description:** Sets the URL for the NTP server.

**Values:**        Text string                **Default:**        us.pool.ntp.org

---

**Setting:**        time\_date.ntp\_dhcp\_option

**Description:** Enables or disables DHCP option 42 to find the NTP server.

**Values:**        0 (disabled), 1 (enabled)   **Default:**        0

---

**Setting:**        time\_date.selected\_timezone

**Description:** Sets the local timezone.

---

**Values:** Pacific/Pago\_Pago, Pacific/Honolulu, America/Adak, America/Anchorage, America/Vancouver, America/Tijuana, America/Los\_Angeles, America/Edmonton, America/Chihuahua, America/Denver, America/Phoenix, America/Winnipeg, Pacific/Easter, America/Mexico\_City, America/Chicago, America/Nassau, America/Montreal, America/Grand\_Turk, America/Havana, America/New\_York, America/Caracas, America/Halifax, America/Santiago, America/Asuncion, Atlantic/Bermuda, Atlantic/Stanley, America/Port\_of\_Spain, America/St\_Johns, America/Godthab, America/Argentina/Buenos\_Aires, America/Fortaleza, America/Sao\_Paulo, America/Noronha, Atlantic/Azores, GMT, America/Danmarkshavn, Atlantic/Faroe, Europe/Dublin, Europe/Lisbon, Atlantic/Canary, Europe/London, Africa/Casablanca, Europe/Tirane, Europe/Vienna, Europe/Brussels, Europe/Zagreb, Europe/Prague, Europe/Copenhagen, Europe/Paris, Europe/Berlin, Europe/Budapest, Europe/Rome, Europe/Luxembourg, Europe/Skopje, Europe/Amsterdam, Africa/Windhoek, Europe/Tallinn, Europe/Helsinki, Asia/Gaza, Europe/Athens, Asia/Jerusalem, Asia/Amman, Europe/Riga, Asia/Beirut, Europe/Chisinau, Europe/Kaliningrad, Europe/Bucharest, Asia/Damascus, Europe/Istanbul, Europe/Kiev, Africa/Djibouti, Asia/Baghdad, Europe/Moscow, Asia/Tehran, Asia/Yerevan, Asia/Baku, Asia/Tbilisi, Asia/Aqtau, Europe/Samara, Asia/Aqtobe, Asia/Bishkek, Asia/Karachi, Asia/Yekaterinburg, Asia/Kolkata, Asia/Almaty, Asia/Novosibirsk, Asia/Krasnoyarsk, Asia/Bangkok, Asia/Shanghai, Asia/Singapore, Australia/Perth, Asia/Seoul, Asia/Tokyo, Australia/Adelaide, Australia/Darwin, Australia/Sydney, Australia/Brisbane, Australia/Hobart, Asia/Vladivostok, Australia/Lord\_Howe, Pacific/Noumea, Pacific/Auckland, Pacific/Chatham, Pacific/Tongatapu

---

---

**Setting:** `time_date.daylight_saving_auto_adjust`  
**Description:** Sets the device to automatically adjust clock for daylight savings.  
**Values:** 0 (disabled), 1 (enabled)    **Default:** 1

---

**Setting:** `time_date.daylight_saving_user_defined`  
**Description:** Enables or disables manual daylight savings configuration.  
**Values:** 0 (disabled), 1 (enabled)    **Default:** 0

---

**Setting:** `time_date.daylight_saving_start_month`  
**Description:** Sets the month that daylight savings time starts.  
**Values:** January–December    **Default:** March

---

**Setting:** `time_date.daylight_saving_start_week`  
**Description:** Sets the week that daylight savings time starts.  
**Values:** 1–5    **Default:** 2

---

**Setting:** `time_date.daylight_saving_start_day`  
**Description:** Sets the day that daylight savings time starts.  
**Values:** Sunday, Monday, Tuesday, Wednesday, Thursday, Friday, Saturday    **Default:** Sunday

---

**Setting:** `time_date.daylight_saving_start_hour`  
**Description:** Sets the hour that daylight savings time starts.  
**Values:** 00:00–23:00    **Default:** 02:00

---

**Setting:** `time_date.daylight_saving_end_month`  
**Description:** Sets the month that daylight savings time ends.  
**Values:** January–December    **Default:** November

---

<b>Setting:</b>	<code>time_date.daylight_saving_end_week</code>		
<b>Description:</b>	Sets the week that daylight savings time ends.		
<b>Values:</b>	1–5	<b>Default:</b>	1
<b>Setting:</b>	<code>time_date.daylight_saving_end_day</code>		
<b>Description:</b>	Sets the day that daylight savings time ends.		
<b>Values:</b>	Sunday, Monday, Tuesday, Wednesday, Thursday, Friday, Saturday	<b>Default:</b>	Sunday
<b>Setting:</b>	<code>time_date.daylight_saving_end_hour</code>		
<b>Description:</b>	Sets the hour that daylight savings time ends.		
<b>Values:</b>	00:00–23:00	<b>Default:</b>	02:00
<b>Setting:</b>	<code>time_date.daylight_saving_amount</code>		
<b>Description:</b>	Sets the daylight savings time offset in minutes.		
<b>Values:</b>	0–255	<b>Default:</b>	60
<b>Setting:</b>	<code>time_date.timezone_dhcp_option</code>		
<b>Description:</b>	Enables or disables DHCP option 2/100/101 for determining timezone information.		
<b>Values:</b>	0 (disabled), 1 (enabled)	<b>Default:</b>	0
<b>Setting:</b>	<code>time_date.ntp_server_update_interval</code>		
<b>Description:</b>	Sets the delay between NTP server updates, in seconds.		
<b>Values:</b>	0–4294967295	<b>Default:</b>	1000
<b>Setting:</b>	<code>time_date.time_and_date</code>		
<b>Description:</b>	Manually sets the date and time. Use the format <year>-<month>-<day>T<hour>:<minute>:<second>		
<b>Values:</b>	<year>-<month>-<day>T <hour>:<minute>:<second>	<b>Default:</b>	2015-01-01T12:00:00



## "log" Module: Log Settings

The log settings control system logging activities. System logging may be required for troubleshooting purposes. The following logging modes are supported:

- Serial/Console—system log output to an external console using a serial/RS-232 cable
- Syslog server—output to a log file on a separate server
- Volatile file

The log settings follow the format: log.[element].

All the log settings are included in the general configuration file.

<b>Setting:</b>	<code>log.syslog_enable</code>		
<b>Description:</b>	Enables or disables log output to syslog server.		
<b>Values:</b>	0 (disabled), 1 (enabled)	<b>Default:</b>	0
<b>Setting:</b>	<code>log.syslog_server_address</code>		
<b>Description:</b>	Sets the syslog server IP address.		
<b>Values:</b>	Text string (IPv4)	<b>Default:</b>	Blank
<b>Setting:</b>	<code>log.syslog_server_port</code>		
<b>Description:</b>	Sets the syslog server port.		
<b>Values:</b>	1–65535	<b>Default:</b>	514
<b>Setting:</b>	<code>log.syslog_level</code>		
<b>Description:</b>	Sets the log level. The higher the level, the larger the debug output. 5—all 4— debug 3—info 2—warning 1— error 0—critical		
<b>Values:</b>	0–5	<b>Default:</b>	2

## "remoteDir" Module: Remote Directory Settings

The remote directory settings follow the format: remoteDir.[element].

All these settings are exported when you manually export the configuration from the C520.

All the remote directory settings are included in the general configuration file.

---

<b>Setting:</b>	<code>remoteDir.ldap_enable</code>		
<b>Description:</b>	Enables or disables the C520 conference phone's access to the LDAP directory.		
<b>Values:</b>	0 (disabled), 1 (enabled)	<b>Default:</b>	0

---

<b>Setting:</b>	<code>remoteDir.ldap_directory_name</code>		
<b>Description:</b>	Sets the LDAP directory name.		
<b>Values:</b>	Text string	<b>Default:</b>	Blank

---

<b>Setting:</b>	<code>remoteDir.ldap_server_address</code>		
<b>Description:</b>	Sets the LDAP server IP address.		
<b>Values:</b>	Text string	<b>Default:</b>	Blank

---

<b>Setting:</b>	<code>remoteDir.ldap_port</code>		
<b>Description:</b>	Sets the LDAP server port.		
<b>Values:</b>	1-65535	<b>Default:</b>	389

---

<b>Setting:</b>	<code>remoteDir.ldap_protocol_version</code>		
<b>Description:</b>	Sets the LDAP protocol version.		
<b>Values:</b>	version_2, version_3	<b>Default:</b>	version_3

---

<b>Setting:</b>	<code>remoteDir.ldap_authentication_type</code>		
<b>Description:</b>	Sets the LDAP authentication type.		
<b>Values:</b>	simple, ssl	<b>Default:</b>	simple

---

<b>Setting:</b>	<code>remoteDir.ldap_user_name</code>		
<b>Description:</b>	Sets the LDAP authentication user name.		
<b>Values:</b>	Text string	<b>Default:</b>	Blank
<b>Setting:</b>	<code>remoteDir.ldap_access_password</code>		
<b>Description:</b>	Sets the LDAP authentication password.		
<b>Values:</b>	Text string	<b>Default:</b>	Blank
<b>Setting:</b>	<code>remoteDir.ldap_base</code>		
<b>Description:</b>	Sets the LDAP search base. This sets where the search begins in the directory tree structure. Enter one or more attribute definitions, separated by commas (no spaces). Your directory may include attributes like "cn" (common name) or "ou" (organizational unit) or "dc" (domain component). For example, ou=accounting,dc=vtech,dc=com		
<b>Values:</b>	Text string	<b>Default:</b>	Blank
<b>Setting:</b>	<code>remoteDir.ldap_max_hits</code>		
<b>Description:</b>	Sets the maximum number of entries returned for an LDAP search. Limiting the number of hits can conserve network bandwidth.		
<b>Values:</b>	0-32000	<b>Default:</b>	200
<b>Setting:</b>	<code>remoteDir.ldap_search_delay</code>		
<b>Description:</b>	Sets the LDAP maximum search delay in seconds.		
<b>Values:</b>	0-500	<b>Default:</b>	0
<b>Setting:</b>	<code>remoteDir.ldap_firstname_filter</code>		
<b>Description:</b>	Sets the LDAP first name attribute filter.		
<b>Values:</b>	Text string	<b>Default:</b>	Firstname
<b>Setting:</b>	<code>remoteDir.ldap_lastname_filter</code>		
<b>Description:</b>	Sets the LDAP last name attribute filter.		
<b>Values:</b>	Text string	<b>Default:</b>	Lastname

---

<b>Setting:</b>	<code>remoteDir.ldap_number_filter</code>
<b>Description:</b>	Sets the LDAP number filter.
<b>Values:</b>	Text string
<b>Default:</b>	Blank

---

<b>Setting:</b>	<code>remoteDir.ldap_firstname_attribute</code>
<b>Description:</b>	Sets the name attributes. Enter the name attributes that you want the C520 to display for each entry returned after an LDAP search. Separate each attribute with a space. For example, givenName sn will display the first name and surname for each entry.
<b>Values:</b>	Text string
<b>Default:</b>	Blank

---

<b>Setting:</b>	<code>remoteDir.ldap_lastname_attribute</code>
<b>Description:</b>	Sets the last name attributes.
<b>Values:</b>	Text string
<b>Default:</b>	Blank

---

<b>Setting:</b>	<code>remoteDir.ldap_work_number_attributes</code>
<b>Description:</b>	Sets the number attributes. Enter the number attributes that you want the C520 to display for each entry returned after an LDAP search. Separate each attribute with a space. For example, telephoneNumber mobile will display the work phone number and mobile phone number for each entry.
<b>Values:</b>	Text string
<b>Default:</b>	Blank

---

<b>Setting:</b>	<code>remoteDir.ldap_mobile_number_attributes</code>
<b>Description:</b>	Sets the mobile number attributes.
<b>Values:</b>	Text string
<b>Default:</b>	Blank

---

<b>Setting:</b>	<code>remoteDir.ldap_other_number_attributes</code>
<b>Description:</b>	Sets the "other" number attributes.
<b>Values:</b>	Text string
<b>Default:</b>	Blank

---

---

**Setting:** `remoteDir.ldap_incall_lookup_enable`

**Description:** Enables or disables LDAP incoming call lookup. If enabled, the C520 searches the LDAP directory for the incoming call number. If the number is found, the C520 uses the LDAP entry for CID info.

**Values:** 0 (disabled), 1 (enabled)      **Default:** 0

---

**Setting:** `remoteDir.ldap_outcall_lookup_enable`

**Description:** Enables or disables LDAP outgoing call lookup. If enabled, numbers entered in pre-dial or live dial are matched against LDAP entries. If a match is found, the LDAP entry is displayed for dialing.

**Values:** 0 (disabled), 1 (enabled)      **Default:** 0

---

**Setting:** `remoteDir.broadsoft_enable`

**Description:** Enables or disables the Broadsoft phonebook.

**Values:** 0 (disabled), 1 (enabled)      **Default:** 0

---

**Setting:** `remoteDir.broadsoft_display_name`

**Description:** Sets the Broadsoft Phonebook display name.

**Values:** Text string      **Default:** Blank

---

**Setting:** `remoteDir.broadsoft_server`

**Description:** Sets the Broadsoft Phonebook IP address.

**Values:** Text string      **Default:** Blank

---

**Setting:** `remoteDir.broadsoft_port`

**Description:** Sets the Broadsoft Phonebook port.

**Values:** 1–65535      **Default:** 0

---

**Setting:** `remoteDir.broadsoft_user_name`

**Description:** Sets the Broadsoft Phonebook authentication user name.

**Values:** Text string      **Default:** Blank

---

---

<b>Setting:</b>	<code>remoteDir.broadsoft_access_password</code>		
<b>Description:</b>	Sets the Broadsoft Phonebook authentication password.		
<b>Values:</b>	Text string	<b>Default:</b>	Blank

---

<b>Setting:</b>	<code>remoteDir.broadsoft_dir_type</code>		
<b>Description:</b>	Sets the Broadsoft Phonebook directory type.		
<b>Values:</b>	Group, GroupCommon, Enterprise, EnterpriseCommon, Personal	<b>Default:</b>	Group

---

<b>Setting:</b>	<code>remoteDir.ldap_check_certificate</code>		
<b>Description:</b>	Enables or disables accepting only a trusted LDAP certificate.		
<b>Values:</b>	0 (disabled), 1 (enabled)	<b>Default:</b>	0

---

<b>Setting:</b>	<code>remoteDir.broadsoft_check_certificate</code>		
<b>Description:</b>	Enables or disables accepting only a trusted Broadsoft certificate.		
<b>Values:</b>	0 (disabled), 1 (enabled)	<b>Default:</b>	0

---

## "web" Module: Web Settings

The web settings control the web server IP, port, and security settings.

The web settings follow the format: web.[element].

All the web settings are included in the general configuration file.

---

<b>Setting:</b>	<code>web.http_port</code>		
<b>Description:</b>	Sets the http port when http is enabled.		
<b>Values:</b>	1-65535	<b>Default:</b>	80

---

---

<b>Setting:</b>	<code>web.https_enable</code>		
<b>Description:</b>	Sets server to use the https protocol.		
<b>Values:</b>	0 (disabled), 1 (enabled)	<b>Default:</b>	0

---

---

<b>Setting:</b>	<code>web.https_port</code>		
<b>Description:</b>	Sets the https port when https is enabled.		
<b>Values:</b>	1-65535	<b>Default:</b>	443

---

## "user\_pref" Module: User Preference Settings

The user settings are accessible to the C520 user. These settings are useful for initial setup. You may wish to remove these settings from auto-provisioning update files so that users do not have their own settings overwritten.

The user preference settings follow the format: `user_pref.[element]`.

The user preference settings are exported when you manually export the configuration from the C520.

### General configuration file settings

---

**Setting:** `user_pref.account.x.ringer`

**Description:** Sets the ring tone for account x.

**Values:** 1–10 **Default:** 1

---

**Setting:** `user_pref.web_language`

**Description:** Sets the language that appears on the WebUI.

**Values:** en, fr, es **Default:** en

---

**Setting:** `user_pref.language`

**Description:** Sets the language that appears on the device screen.

**Values:** en, fr, es **Default:** en

---

**Setting:** `user_pref.idle_to_logo_timeout`

**Description:** Sets the delay (in seconds) before the logo replaces the idle screen.

**Values:** 0 (disabled)–300 **Default:** 0

---

**Setting:** `user_pref.logo_to_idle_timeout`

**Description:** Sets the delay (in seconds) before the idle screen replaces the logo. This parameter enables the LCD to cycle between the idle screen and the logo.

**Values:** 1–300 **Default:** 60

---



---

**Setting:** `user_pref.notify.led.missed_call.enable`

**Description:** Sets how the Message Waiting LED operates. When enabled, the LED turns on for missed calls and new messages. When disabled, the LED turns on for new messages only.  
**Note:** This setting is not available on the phone menu or WebUI.

**Values:** 0 (disabled), 1 (enabled)      **Default:** 0

---

**Setting:** `user_pref.text_input_option`

**Description:** Sets the order and available language input options available when users edit or enter text on the LCD.  
**Note:** This setting is not available on the phone menu or WebUI, and applies to models sold and installed outside North America only.

**Values:** number,uc\_western,lc\_western,uc\_ru,lc\_ru,uc\_el,lc\_el      **Default:** uc\_western,lc\_western,number

---

**Setting:** `user_pref.call_terminated.busy_tone_enable`

**Description:** Enables the C520 to play a busy tone when the far-end party ends the call, or when a network error condition (keep-alive failure) occurs.

**Values:** 0 (disabled), 1 (enabled)      **Default:** 0

---

## MAC-specific configuration file settings

---

**Setting:** `user_pref.backlight_timeout`

**Description:** Sets the backlight timeout in seconds.

**Values:** 10–60      **Default:** 30

---

**Setting:** `user_pref.ringer_volume`

**Description:** Sets the ringer volume (0 is OFF).

**Values:** 0-9      **Default:** 5

---

**Setting:** `user_pref.hold_reminder.enable`

**Description:** Enables or disables audible hold reminder.

**Values:** 0 (disabled), 1 (enabled)      **Default:** 1

---

<b>Setting:</b>	<code>user_pref.hold_reminder.interval</code>		
<b>Description:</b>	Sets the interval for the audible hold reminder in seconds.		
<b>Values:</b>	10–300	<b>Default:</b>	30
<b>Setting:</b>	<code>user_pref.call_waiting.tone_enable</code>		
<b>Description:</b>	Enables or disables the call waiting tone.		
<b>Values:</b>	0 (disabled), 1 (enabled)	<b>Default:</b>	1
<b>Setting:</b>	<code>user_pref.call_waiting.tone_interval</code>		
<b>Description:</b>	Sets the interval for the call waiting tone in seconds.		
<b>Values:</b>	10–60	<b>Default:</b>	30
<b>Setting:</b>	<code>user_pref.call_waiting.mode</code>		
<b>Description:</b>	Enables or disables rejecting calls if already on a call.		
<b>Values:</b>	0 (disabled), 1 (enabled)	<b>Default:</b>	1
<b>Setting:</b>	<code>user_pref.lcd_contrast</code>		
<b>Description:</b>	Sets the LCD contrast on the C520. 1–		
<b>Values:</b>	7	<b>Default:</b>	4
<b>Setting:</b>	<code>user_pref.backlight</code>		
<b>Description:</b>	Sets the backlight brightness level.		
<b>Values:</b>	off, low, medium, high	<b>Default:</b>	high
<b>Setting:</b>	<code>user_pref.idle_backlight</code>		
<b>Description:</b>	Sets the backlight brightness level when the C520 is idle.		
<b>Values:</b>	off, low, medium, high	<b>Default:</b>	off
<b>Setting:</b>	<code>user_pref.absent_timeout</code>		
<b>Description:</b>	Sets the absent timeout (the interval after going off hook with no action taken) in seconds. After the absent timeout, the phone returns to idle mode.		
<b>Values:</b>	10–60	<b>Default:</b>	30

---

<b>Setting:</b>	<code>user_pref.speaker_volume</code>		
<b>Description:</b>	Sets the speakerphone volume.		
<b>Values:</b>	1-9	<b>Default:</b>	5

---

<b>Setting:</b>	<code>user_pref.key_beep_enable</code>		
<b>Description:</b>	Enables or disables key beeps on the C520.		
<b>Values:</b>	0 (disabled), 1 (enabled)	<b>Default:</b>	1

---

## "call\_settings" Module: Call Settings

The call settings configure data related to a user's call preferences. The data is stored internally at /mnt/flash/CallSettings.xml.

All the call settings (except one) follow the format: `call_settings.account.x.[element]` where `x` is an account number ranging from 1 to 3.

All the call settings are included in the MAC-specific configuration file.

---

**Setting:** `call_settings.account.x.block_anonymous_enable`

**Description:** Enables or disables anonymous call blocking.

**Values:** 0 (disabled), 1 (enabled)      **Default:** 0

---

**Setting:** `call_settings.account.x.outgoing_anonymous_enable`

**Description:** Enables or disables outgoing anonymous calls.

**Values:** 0 (disabled), 1 (enabled)      **Default:** 0

---

**Setting:** `call_settings.account.x.dnd_enable`

**Description:** Enables or disables Do Not Disturb for account `x`.

**Values:** 0 (disabled), 1 (enabled)      **Default:** 0

---

**Setting:** `call_settings.account.x.dnd_incoming_calls`

**Description:** Sets whether incoming calls are shown or rejected when DND is on for account `x`.

**Values:** show, reject      **Default:** reject

---

**Setting:** `call_settings.account.x.call_fwd_always_enable`

**Description:** Enables or disables Call Forward Always for account `x`.

**Values:** 0 (disabled), 1 (enabled)      **Default:** 0

---

**Setting:** `call_settings.account.x.call_fwd_always_target`

**Description:** Sets the Call Forward Always target number for account `x`.

**Values:** Text string      **Default:** Blank

---

<b>Setting:</b>	<code>call_settings.account.x.call_fwd_busy_enable</code>		
<b>Description:</b>	Enables or disables Call Forward Busy for account x.		
<b>Values:</b>	0 (disabled), 1 (enabled)	<b>Default:</b>	0
<b>Setting:</b>	<code>call_settings.account.x.call_fwd_busy_target</code>		
<b>Description:</b>	Sets the Call Forward Busy target number for account x.		
<b>Values:</b>	Text string	<b>Default:</b>	Blank
<b>Setting:</b>	<code>call_settings.account.x.cfna_enable</code>		
<b>Description:</b>	Enables or disables Call Forward No Answer for account x.		
<b>Values:</b>	0 (disabled), 1 (enabled)	<b>Default:</b>	0
<b>Setting:</b>	<code>call_settings.account.x.cfna_target</code>		
<b>Description:</b>	Sets the Call Forward No Answer target number for account x.		
<b>Values:</b>	Text string	<b>Default:</b>	Blank
<b>Setting:</b>	<code>call_settings.account.x.cfna_delay</code>		
<b>Description:</b>	Sets the Call Forward No Answer delay (in number of rings) for account x.		
<b>Values:</b>	1–10	<b>Default:</b>	6
<b>Setting:</b>	<code>call_settings.missed_call_alert_enable</code>		
<b>Description:</b>	Enables or disables missed call alerts.		
<b>Values:</b>	0 (disabled), 1 (enabled)	<b>Default:</b>	1

## "speed\_dial" Module: Speed Dial Settings

The speed dial key settings configure the dial pad keys for speed dialing pre-programmed phone numbers. When configured, the C520 user can press and hold a dial pad key to dial a programmed phone number.

The speed dial key settings follow the format `speed_dial.x.[element]`, where x is the dial pad key, ranging from 1 to 0 (with 0 being the "0" OPER key).

All the speed dial settings are included in the MAC-specific configuration file.

---

<b>Setting:</b>	<code>speed_dial.x.name</code>		
<b>Description:</b>	Sets the name associated with the phone number for dial pad key x. The name is visible on the C520 LCD.		
<b>Values:</b>	Text string	<b>Default:</b>	Blank

---

---

<b>Setting:</b>	<code>speed_dial.x.number</code>		
<b>Description:</b>	Sets the phone number that dial pad key x dials when pressed and held.		
<b>Values:</b>	Text string (SIP URI)	<b>Default:</b>	Blank

---

---

<b>Setting:</b>	<code>speed_dial.x.account</code>		
<b>Description:</b>	Sets the SIP account used for dialing when dial pad key x is pressed and held.		
<b>Values:</b>	0-3 (0 is the default account)	<b>Default:</b>	0

---

## "ringersetting" Module: Distinctive Ringer Settings

The distinctive ringer settings configure the distinctive ringer feature. For more information, see *"Ringer Settings" on page 53*. You can configure up to 8 instances of the distinctive ringer feature.

The ringer setting parameters follow the format `ringersetting.x.[element]`, where `x` is the instance of the setting, ranging from 1 to 8.

All the ringer settings are included in the general configuration file.

---

<b>Setting:</b>	<code>ringersetting.x.ringer_text</code>		
<b>Description:</b>	Enter the text that will match the "info" parameter and play the ringer tone. The matching of the "info" parameter and <code>ringer_text</code> setting is case sensitive.		
<b>Values:</b>	Text string in the format <b>ringerx</b> (e.g., <code>ringer1</code> )	<b>Default:</b>	Blank

---

---

<b>Setting:</b>	<code>ringersetting.x.ringer_type</code>		
<b>Description:</b>	Select the desired ring tone for ringer setting <code>x</code> .		
<b>Values:</b>	1–10	<b>Default:</b>	1

---

## "file" Module: Imported File Settings

The "file" parameters enable the provisioning file to import additional configuration files of various types, including:

- Contact lists
- Custom logos
- Security certificates

The following certificates are supported:

- Per-account TLS certificate (you can choose to use the Account 1 certificate for all accounts)
- Broadsoft directory
- LDAP
- Web server (the C520 has a default self-signed web server certificate)
- Provisioning
- Languages

File parameter values are URLs that direct the C520 to the location of the file to be imported.

None of these settings are exported when you manually export the configuration from the C520.

### General configuration file settings

---

**Setting:** `file.https_user.certificate`

**Description:** URI of HTTPS server certificate to be imported; for example, `<protocol>://<user>:<password>@<host>:<port>/<url-path>`

**Values:** Text string                      **Default:** Blank

---

**Setting:** `file.provisioning.trusted.certificate`

**Description:** URI of provisioning certificate to be imported; for example, `<protocol>://<user>:<password>@<host>:<port>/<url-path>`

**Values:** Text string                      **Default:** Blank

---



---

<b>Setting:</b>	<b>file.sips.trusted.certificate.x</b>		
<b>Description:</b>	URI of SIPS (TLS transport) certificate to be imported for account x; for example, <protocol>://<user>:<password>@<host>:<port>/<url-path>		
<b>Values:</b>	Text string	<b>Default:</b>	Blank

---

<b>Setting:</b>	<b>file.ldap.trusted.certificate</b>		
<b>Description:</b>	URI of LDAP certificate to be imported; for example, <protocol>://<user>:<password>@<host>:<port>/<url-path>		
<b>Values:</b>	Text string	<b>Default:</b>	Blank

---

### MAC-specific configuration file settings

---

<b>Setting:</b>	<b>file.broadsoft.trusted.certificate</b>		
<b>Description:</b>	URI of Broadsoft certificate to be imported; for example, <protocol>://<user>:<password>@<host>:<port>/<url-path>		
<b>Values:</b>	Text string	<b>Default:</b>	Blank

---

<b>Setting:</b>	<b>file.contact.directory.append</b>		
<b>Description:</b>	URL of contact directory to be imported. Entries in the imported file will be added to existing directory entries.		
<b>Values:</b>	Text string	<b>Default:</b>	Blank

---

<b>Setting:</b>	<b>file.contact.directory.overwrite</b>		
<b>Description:</b>	URL of contact directory to be imported. Entries in the imported file will replace all existing directory entries.		
<b>Values:</b>	Text string	<b>Default:</b>	Blank

---

<b>Setting:</b>	<b>file.contact.blacklist.append</b>		
<b>Description:</b>	URL of contact blacklist to be imported. Entries in the imported file will be added to existing blacklist entries.		
<b>Values:</b>	Text string	<b>Default:</b>	Blank

---

---

<b>Setting:</b>	<code>file.contact.blacklist.override</code>
<b>Description:</b>	URL of contact blacklist to be imported. Entries in the imported file will replace all existing directory entries.
<b>Values:</b>	Text string
<b>Default:</b>	Blank

---

<b>Setting:</b>	<code>file.bootup_logo</code>
<b>Description:</b>	URL of custom logo shown during bootup. For logo specifications, see <i>“Logo specifications” on page 15</i> . To restore the default “VTech” logo, set the value to %NULL in the configuration file. For example: <code>file.bootup_logo = %NULL</code>
<b>Values:</b>	Text string
<b>Default:</b>	Blank

---

<b>Setting:</b>	<code>file.idle_logo</code>
<b>Description:</b>	URL of custom logo shown on the idle screen. For logo specifications, see <i>“Logo specifications” on page 15</i> . To restore the default “VTech” logo, set the value to %NULL in the configuration file. For example: <code>file.idle_logo = %NULL</code>
<b>Values:</b>	Text string
<b>Default:</b>	Blank

---

## "tone" Module: Tone Definition Settings

The Tone Definition settings configure data for various tones for the purpose of localization. The Audio Manager component uses the data from this model to populate the mcu on bootup.

Each tone definition must be a string of 12 elements separated by a space:

```
"<num of freq> <freq1> <amp1> <freq2> <amp2> <freq3> <amp3> <freq4> <amp4>
<on duration> <off duration> <repeat count>"
```

Where:

<num of freq>: 0-4

<freq1>: 0-65535

<amp1>: -32768-32767

<freq2>: 0-65535

<amp2>: -32768-32767

<freq3>: 0-65535

<amp3>: -32768-32767

<freq4>: 0-65535

<amp4>: -32768-32767

<on duration>: 0-2<sup>32</sup>

<off duration>: 0-2<sup>32</sup>

<repeat count>: 0-65535

All the tone definition settings are included in the general configuration file.

---

**Setting:** `tone.call_waiting_tone.num_of_elements`

**Description:** Sets the number of elements for the call waiting tone.

**Values:** 1-5                                      **Default:** 1

---

**Setting:** `tone.call_waiting_tone.element.1`

**Description:** Defines the call waiting tone element 1.

**Values:** Tone element string                      **Default:** 1 440 -150 0 0 0 0 0 500 0 1

---

<b>Setting:</b>	<code>tone.call_waiting_tone.element.x</code>		
<b>Description:</b>	Defines the call waiting tone element x.		
<b>Values:</b>	Tone element string	<b>Default:</b>	Blank
<b>Setting:</b>	<code>tone.hold_reminder.num_of_elements</code>		
<b>Description:</b>	Sets the number of tone elements for the hold reminder tone.		
<b>Values:</b>	1–5	<b>Default:</b>	1
<b>Setting:</b>	<code>tone.hold_reminder.element.1</code>		
<b>Description:</b>	Defines the hold reminder tone element 1.		
<b>Values:</b>	Tone element string	<b>Default:</b>	1 770 -120 0 0 0 0 0 0 300 0 1
<b>Setting:</b>	<code>tone.hold_reminder.element.x</code>		
<b>Description:</b>	Defines the hold reminder tone element x.		
<b>Values:</b>	Tone element string	<b>Default:</b>	Blank
<b>Setting:</b>	<code>tone.inside_dial_tone.num_of_elements</code>		
<b>Description:</b>	Sets the number of tone elements for the dialtone.		
<b>Values:</b>	1–5	<b>Default:</b>	1
<b>Setting:</b>	<code>tone.inside_dial_tone.element.1</code>		
<b>Description:</b>	Defines the inside dial tone element 1.		
<b>Values:</b>	Tone element string	<b>Default:</b>	2 440 -180 350 -180 0 0 0 0 4294967295 0 65535
<b>Setting:</b>	<code>tone.inside_dial_tone.element.x</code>		
<b>Description:</b>	Defines the inside dial tone element x.		
<b>Values:</b>	Tone element string	<b>Default:</b>	Blank
<b>Setting:</b>	<code>tone.stutter_dial_tone.num_of_elements</code>		
<b>Description:</b>	Sets the number of tone elements for the stutter dialtone.		
<b>Values:</b>	1–5	<b>Default:</b>	2

<b>Setting:</b>	<code>tone.stutter_dial_dial_tone.element.1</code>		
<b>Description:</b>	Defines the stutter dial tone element 1.		
<b>Values:</b>	Tone element string	<b>Default:</b>	2 440 -180 350 -180 0 0 0 0 100 100 10
<b>Setting:</b>	<code>tone.stutter_dial_dial_tone.element.2</code>		
<b>Description:</b>	Defines the stutter dial tone element 2.		
<b>Values:</b>	Tone element string	<b>Default:</b>	2 440 -180 350 -180 0 0 0 0 4294967295 0 65535
<b>Setting:</b>	<code>tone.stutter_dial_tone.element.x</code>		
<b>Description:</b>	Defines the stutter dial tone element x.		
<b>Values:</b>	Tone element string	<b>Default:</b>	Blank
<b>Setting:</b>	<code>tone.busy_tone.num_of_elements</code>		
<b>Description:</b>	Sets the number of tone elements for the busy tone.		
<b>Values:</b>	1–5	<b>Default:</b>	2
<b>Setting:</b>	<code>tone.busy_tone.element.1</code>		
<b>Description:</b>	Defines the busy tone element 1.		
<b>Values:</b>	Tone element string	<b>Default:</b>	2 480 -180 620 -180 0 0 0 0 500 500 65535
<b>Setting:</b>	<code>tone.busy_tone.element.x</code>		
<b>Description:</b>	Defines the busy tone element x.		
<b>Values:</b>	Tone element string	<b>Default:</b>	Blank
<b>Setting:</b>	<code>tone.ring_back_tone.num_of_elements</code>		
<b>Description:</b>	Sets the number of tone elements for the ringback tone.		
<b>Values:</b>	1–5	<b>Default:</b>	1

<b>Setting:</b>	<code>tone.ring_back_tone.element.1</code>		
<b>Description:</b>	Defines the ringback tone element 1.		
<b>Values:</b>	Tone element string	<b>Default:</b>	2 440 -180 480 -180 0 0 0 0 2000 4000 65535
<b>Setting:</b>	<code>tone.ring_back_tone.element.x</code>		
<b>Description:</b>	Defines the ringback tone element x.		
<b>Values:</b>	Tone element string	<b>Default:</b>	Blank

## "profile" Module: Password Settings

The password settings allow you to set the default administrator and user passwords in the configuration file. The administrator password is usually included in the general configuration file, while the user password is usually included in the MAC-specific configuration file. The passwords can also be set using the WebUI. Be aware that scheduled provisioning configuration file updates may reset these passwords.

### General configuration file settings

<b>Setting:</b>	<code>profile.admin.access_password</code>		
<b>Description:</b>	Sets the administrator password for accessing the admin menus on the C520 and the WebUI.		
<b>Values:</b>	Text string (15 characters maximum)	<b>Default:</b>	admin

### MAC-specific configuration file settings

<b>Setting:</b>	<code>profile.user.access_password</code>		
<b>Description:</b>	Sets the user password for logging on to the WebUI and editing user-accessible settings.		
<b>Values:</b>	Text string (15 characters maximum)	<b>Default:</b>	user

## "page\_zone" Module: Paging Zone Settings

The paging zone settings allow you to define a maximum of 10 paging zones that the C520 can use for multicast paging.

The paging zone parameters (except for `page_zone.call_priority_threshold`) follow the format `page_zone.x.[element]`, where x is the paging zone ID number, ranging from 1 to 10.

All the paging zone settings are included in the general configuration file.

---

<b>Setting:</b>	<code>page_zone.x.name</code>		
<b>Description:</b>	Sets the paging zone name, which appears on C520 LCD for outgoing and incoming multicast pages. A maximum of 15 characters is allowed.		
<b>Values:</b>	Text string	<b>Default:</b>	Blank

---

<b>Setting:</b>	<code>page_zone.x.multicast_address</code>		
<b>Description:</b>	Enter the multicast IP address that the C520 will monitor. The range of valid IP addresses is 224.0.0.0 to 239.255.255.255.		
<b>Values:</b>	IPv4 IP address	<b>Default:</b>	Blank

---

<b>Setting:</b>	<code>page_zone.x.multicast_port</code>		
<b>Description:</b>	Enter the multicast port associated with the multicast IP. The range of valid ports is 1 to 65535.		
<b>Values:</b>	1–65535	<b>Default:</b>	Blank

---

<b>Setting:</b>	<code>page_zone.x.accept_incoming_page</code>		
<b>Description:</b>	Enables or disables the C520 from receiving incoming multicast pages for that paging zone. If disabled, the C520 can make outgoing multicast pages only.		
<b>Values:</b>	0 (disabled), 1 (enabled)	<b>Default:</b>	1

---

<b>Setting:</b>	<code>page_zone.x.priority</code>		
<b>Description:</b>	Set the paging zone priority from 1 to 10. Zones with a priority higher than another zone can interrupt the lower-priority zone's active page.		
<b>Values:</b>	1–10	<b>Default:</b>	5

---

---

<b>Setting:</b>	<code>page_zone.call_priority_threshold</code>		
<b>Description:</b>	Set the <code>call_priority_threshold</code> . If the paging zone priority ( <code>page_zone.x.priority</code> ) is higher or equal to the call priority, then a multicast page can interrupt an active, dialing, or incoming call.		
<b>Values:</b>	1–10	<b>Default:</b>	2

---



## "softkey" Module: Custom Soft Key Settings

The custom soft key settings allow you to select which soft keys can appear on the Idle screen, the Call Active screen, the Call Held screen and the Live Dial screen. You can also specify the position of each soft key. Softkeys appear on the C520 screen in the same order as the softkey values you enter. Enter soft key values separated by commas. For more information, see “Customizing Soft Keys” on page 17. You can specify a maximum of nine soft keys (three levels) for each parameter.

The soft key settings follow the format `softkey.[element]`.

All the soft key settings are included in the general configuration file.

---

<b>Setting:</b>	<code>softkey.idle</code>		
<b>Description:</b>	Specifies the soft keys visible on the idle screen.		
<b>Values:</b>	blank, dir , call_log, redial, message, dnd, cfwd, cfna, cfwd_all, cfwd_busy, intercom, retrieve, callback, grp_pickup, dir_pickup, line, settings, pgm_dial_1, pgm_dial_2, pgm_dial_3, bt_connect, bt_device1, bt_device2	<b>Default:</b>	redial, line, bt_device1, bt_device2, bt_connect, blank, call_log, blank, dir

---

<b>Setting:</b>	<code>softkey.call_active</code>		
<b>Description:</b>	Specifies the soft keys visible on the active call screen.		
<b>Values:</b>	blank, new, park_call, end, hold, transfer, conf, xferline, conflate, pri_hold, pgm_dial_1, pgm_dial_2, pgm_dial_3, bt_device1, bt_device2, speaker_audio	<b>Default:</b>	end, transfer, conf, bt_device1, bt_device2, speaker_audio, xferline, conflate

---

<b>Setting:</b>	<code>softkey.call_held</code>		
<b>Description:</b>	Specifies the soft keys visible on the held call screen.		
<b>Values:</b>	blank, new, park_call, retrieve, grp_pickup, dir_pickup, end, resume, transfer, conf, xferline, conflate, pgm_dial_1, pgm_dial_2, pgm_dial_3	<b>Default:</b>	end,new,resume,transfer, conf,xferline,conflate

---

<b>Setting:</b>	<code>softkey.live_dial</code>		
<b>Description:</b>	Specifies the soft keys visible on the live dial screen.		
<b>Values:</b>	blank, dir, call_log, redial, message, end, dial, input, cancel, backspc, pgm_dial_1, pgm_dial_2, pgm_dial_3, bt_device1, bt_device2	<b>Default:</b>	backspc,input,dial, bt_device1, bt_device2, redial
<b>Setting:</b>	<code>softkey.program_dial.x.label</code>		
<b>Description:</b>	Sets the label for the program dial soft key. Program dial soft keys are like PFK quick dial keys, and will dial a programmed number using a specified account. You can enable up to three program dial soft keys. x is the program soft key index number: 1, 2 or 3.		
<b>Values:</b>	text string	<b>Default:</b>	blank
<b>Setting:</b>	<code>softkey.program_dial.x.number</code>		
<b>Description:</b>	Sets the number that the program dial soft key will dial. Use ^ in the string to indicate a one-second pause; for example, 3456^789#. x is the program soft key index number: 1, 2 or 3.		
<b>Values:</b>	text string	<b>Default:</b>	blank
<b>Setting:</b>	<code>softkey.program_dial.x.account</code>		
<b>Description:</b>	Sets the account that the program dial soft key uses to dial the number. x is the program soft key index number: 1, 2 or 3.		
<b>Values:</b>	1-3	<b>Default:</b>	1

## "bt\_settings" Module: Bluetooth Settings

The Bluetooth setting allows you to change the PIN that a cell phone must enter before connecting to the C520 via Bluetooth. This PIN also must be entered at the C520 when connecting a Bluetooth headset.

---

**Setting:**            `bt_settings.pincode`

**Description:** Sets the PIN used for connecting Bluetooth devices to the C520.

**Values:**            Four-digit code.                    **Default:**            0000

---

# TROUBLESHOOTING

## Common Troubleshooting Procedures

Follow these procedures to resolve common issues. For more troubleshooting information, see the user's manual for your product.

### **Screen is blank.**

- Make sure the DC power cable is securely plugged into base unit and the power adapter. Make sure the AC power cord is securely plugged into the power adapter and a wall outlet not controlled by a wall switch.

### **Pages are not received.**

- The Page Auto Answer setting is set to Manual. Check the General Account Settings.

### **The firmware upgrade or configuration update isn't working.**

- Before using the WebUI, ensure you have the latest version of your web browser installed. Some menus and controls in older browsers may operate differently than described in this manual.

- Ensure you have specified the correct path to the firmware and configuration files on the **SERVICING > Firmware Upgrade > Auto Upgrade** page and the **SERVICING > Provisioning** page.
- If the phone is not downloading a MAC-specific configuration file, ensure the filename is all upper case.

**Provisioning: "Use DHCP Option" is enabled, but the C520 is not getting a provisioning URL from the DHCP Server.**

- Ensure that DHCP is enabled in Network settings.

# APPENDIX

## Appendix A: Maintenance

### Taking care of your telephone

- Your C520 conference phone contains sophisticated electronic parts, so you must treat it with care.
- Avoid rough treatment.
- Save the original packing materials to protect your C520 conference phone if you ever need to ship it.

### Avoid water

- You can damage your C520 conference phone if it gets wet. Do not install the C520 conference phone near a sink, bathtub or shower.

### Electrical storms

- Electrical storms can sometimes cause power surges harmful to electronic equipment. For your own safety, take caution when using electric appliances during storms.

### Cleaning your telephone

- Your C520 conference phone has a durable plastic casing that should retain its luster for many years. Clean it only with a soft cloth slightly dampened with water or a mild soap.
- Do not use excess water or cleaning solvents of any kind.

Remember that electrical appliances can cause serious injury if used when you are wet or standing in water. If the C520 conference phone should fall into water, **DO NOT RETRIEVE IT UNTIL YOU UNPLUG THE POWER CORD AND NETWORK CABLE FROM THE WALL**, then pull the unit out by the unplugged cords.